

# SHOP MANUAL

**HONDA**

**S90 CL90L C90  
CL90 CD90 CT90**

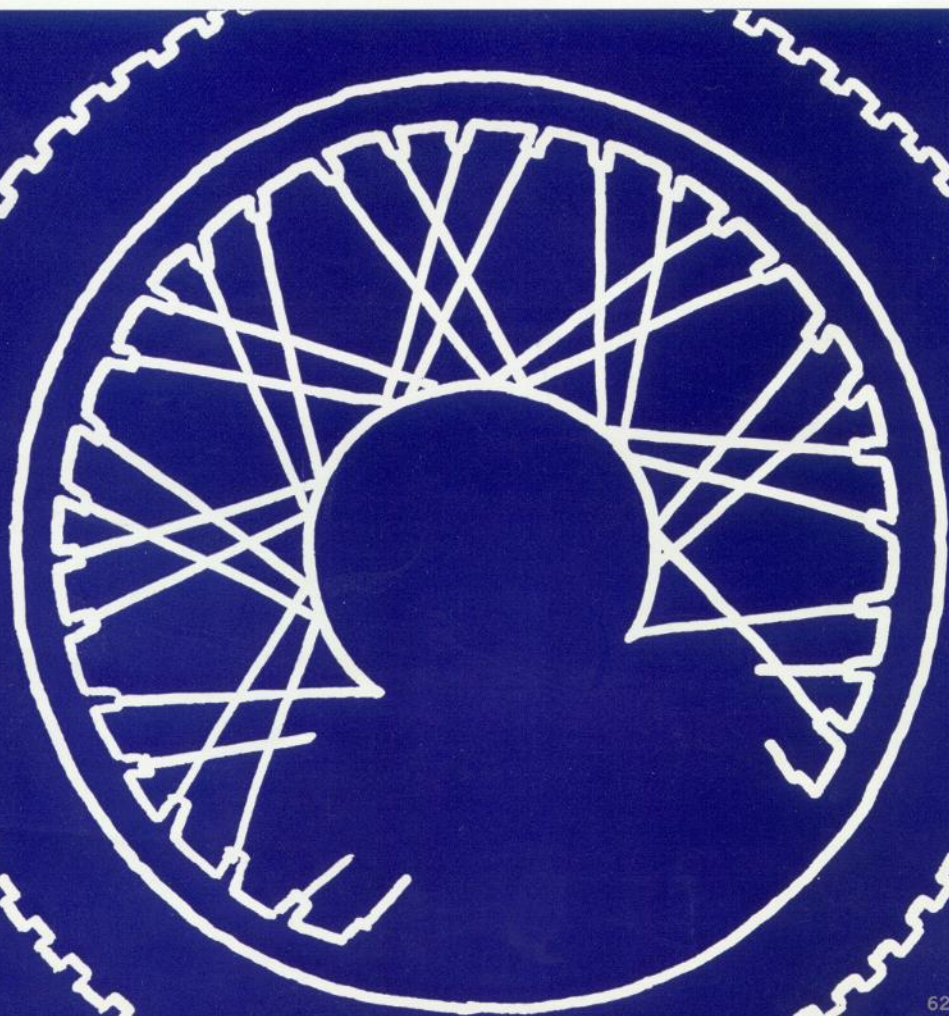

6220003

© SM B 7007910  
PRINTED IN JAPAN

## FOREWORD

This shop manual is a reference and a guide book for the proper servicing of the Honda 90 series motorcycle.

The information contained herein is based on the S 90 with equal applicability to the CL 90, CL 90 L, CD 90, C 90 and CT 90. When no reference is made to any specific model, the information shall be common to all models. Information pertinent to any specific model will be noted.

The manual is prepared in several different parts for convenience and ease in locating the particular information. All servicing information including disassembly, reassembly and inspection procedures are contained in the respective sections for quick reference.

All HONDA products are precisely engineered with precise tolerance for optimum performance, therefore, the procedures outlined should be followed very closely and any repairs or replacements made when the serviceable limit is exceeded. Further, the special tools specified must be used in order to perform the repair or service in a satisfactory manner.

For profitable service operation, all work should be completed promptly and to the satisfaction of the customer, this requires a complete line of anticipated replacement parts readily available.

**HONDA MOTOR CO., LTD.**

SERVICE DIVISION

ALL INFORMATION, ILLUSTRATIONS, DIRECTIONS AND SPECIFICATIONS INCLUDED IN THIS PUBLICATION ARE BASED ON THE LATEST PRODUCT INFORMATION AVAILABLE AT THE TIME OF APPROVAL FOR PRINTING. HONDA MOTOR CO., LTD. RESERVES THE RIGHT TO MAKE CHANGES AT ANY TIME WITHOUT NOTICE AND WITHOUT INCURRING ANY OBLIGATION WHATEVER.

NO PART OF THIS PUBLICATION MAY BE REPRODUCED WITHOUT WRITTEN PERMISSION.

# CONTENTS

<b>1. FEATURES</b> .....	1
1. 1 ENGINE.....	1
1. 2 FRAME.....	1
<b>2. SPECIFICATIONS AND PERFORMANCES</b> .....	2
2. 1 SPECIFICATIONS.....	2
2. 2 PERFORMANCES.....	10
<b>3. ENGINE</b> .....	20
3. 1 ENGINE DESCRIPTION.....	23
3. 2 POWER TRANSMISSION SYSTEM.....	23
3. 3 ENGINE REMOVAL.....	23
3. 4 ENGINE INSTALLATION.....	25
3. 5 CYLINDER HEAD.....	26
A. Construction.....	26
B. Disassembly (Cylinder Head Block).....	26
C. Inspection and Repair.....	28
D. Reassembly.....	34
3. 6 CYLINDER.....	35
A. Construction.....	35
B. Disassembly.....	37
C. Inspection.....	38
D. Reassembly.....	40
3. 7 CAM CHAIN TENSIONER.....	41
A. Construction.....	41
B. Disassembly.....	42
C. Inspection.....	42
D. Reassembly.....	42
3. 8 CLUTCH.....	43
A. Construction.....	43
B. Disassembly.....	45
C. Inspection.....	46
D. Reassembly.....	47
3. 9 OIL PUMP.....	48
A. Construction.....	49
B. Disassembly.....	49

---

C. Inspection .....	50
D. Reassembly .....	50
3. 10 GEAR SHIFT MECHANISM .....	51
A. Construction .....	51
B. Disassembly .....	52
C. Inspection .....	52
D. Reassembly .....	52
3. 11 CRANKSHAFT .....	53
A. Construction .....	53
B. Disassembly .....	53
C. Inspection .....	53
D. Reassembly .....	54
3. 12 TRANSMISSION .....	55
A. Construction .....	55
B. Disassembly .....	58
C. Inspection .....	59
D. Reassembly .....	60
3. 13 CRANKCASE .....	61
A. Construction .....	61
B. Disassembly .....	62
C. Inspection .....	62
D. Reassembly .....	62
3. 14 KICK STARTER AND GEAR INTERLOCK MECHANISM .....	63
3. 15 POSI-TORQUE MECHANISM (CT 90) .....	64
A. Construction .....	64
B. Disassembly .....	65
3. 16 CARBURETOR .....	65
A. Construction .....	65
B. Function of Each Component .....	67
C. Adjustment .....	69
D. Adjustment for High Speed .....	70
E. Adjustment for Intermediate Speed .....	70
F. Adjustment for Slow Speed .....	71
G. Adjusting the Fuel Level .....	71
<b>4. FRAME .....</b>	<b>74</b>
4. 1 STEERING HANDLE .....	75
A. Construction .....	75
B. Disassembly .....	76
C. Inspection (steering handle) .....	78
D. Reassembly .....	79

---

4. 2	STEERING STEM.....	80
A.	Construction.....	80
B.	Disassembly.....	81
C.	Inspection.....	82
D.	Reassembly.....	82
4. 3	FRONT FORK.....	83
A.	Construction.....	83
B.	Disassembly.....	84
C.	Inspection.....	88
D.	Reassembly.....	89
4. 4	FUEL TANK.....	89
A.	Construction.....	89
B.	Disassembly.....	89
C.	Inspection.....	90
D.	Reassembly.....	91
4. 5	FRAME BODY.....	91
A.	Construction.....	91
B.	Disassembly.....	91
C.	Inspection.....	92
D.	Reassembly.....	92
4. 6	SEAT.....	92
A.	Construction.....	92
B.	Disassembly.....	92
C.	Inspection.....	93
D.	Reassembly.....	93
4. 7	BRAKE SYSTEM.....	94
A.	Construction.....	94
B.	Disassembly.....	94
4. 8	MUFFLER.....	97
A.	Construction.....	97
B.	Disassembly.....	97
C.	Inspection.....	97
D.	Reassembly.....	97
4. 9	AIR CLEANER.....	98
A.	Construction.....	98
B.	Disassembly.....	98
C.	Inspection.....	99
D.	Reassembly.....	99
4. 10	REAR FORK AND CUSHION DAMPER.....	100
A.	Construction.....	100
B.	Disassembly.....	100

C. Inspection .....	100
D. Reassembly .....	100
4.11 REAR FORK CUSHION DAMPER .....	101
A. Construction .....	101
B. Disassembly .....	102
C. Inspection .....	103
4.12 FRONT WHEEL .....	104
A. Construction .....	104
B. Disassembly .....	105
C. Inspection .....	106
D. Reassembly .....	107
4.13 REAR WHEEL .....	108
A. Construction .....	108
B. Disassembly .....	109
C. Inspection .....	110
D. Reassembly .....	111
<b>5. PERIODIC ADJUSTMENT .....</b>	<b>113</b>
5.1 MAINTENANCE INSPECTION .....	113
A. Engine Adjustment .....	113
B. Lubricating .....	122
C. Drive Chain Adjustment .....	123
D. Brake Adjustment .....	124
E. Muffler Cleaning .....	125
F. Spoke Torquing .....	125
G. Battery Inspection .....	126
H. Drive Chain Service .....	127
I. Operating Instruction for Service Tester, Type ST-4D4 .....	128
J. Security Inspection of Parts .....	132
5.2 PERIODIC INSPECTION AND SERVICING .....	135
A. Daily Inspection .....	136
B. Periodic Inspection .....	137
<b>6. TROUBLE SHOOTING .....</b>	<b>138</b>
6.1 MAIN ENGINE TROUBLE .....	138
6.2 CARBURETOR TROUBLE .....	140
6.3 ENGINE NOISE .....	141
6.4 STEERING SYSTEM .....	142
6.5 CLUTCH SYSTEM .....	142
6.6 GEAR CHANGE SYSTEM .....	143
6.7 SUSPENSION .....	143

# 1. FEATURES

## 1.1 ENGINE

The engines used on the HONDA 90 series are basically identical with the major difference in that the S 90, CL 90, CL 90 L and CD 90 are equipped with a manually operated clutch and the C 90 and CT 90 having an automatic clutch.

### A. Chain driven overhead camshaft

The camshaft is driven by a constant tension chain, assuring quiet operation and precise valve timing. Further, it enables greater power output due to availability of higher operating RPM.

### B. OHV and semi-spherical combustion chamber

The overhead valve design provides greater air intake into the cylinder and a consequent higher volumetric efficiency.

The semi-spherical combustion chamber assures a smooth flame propagation which is further enhanced by the incorporation of a special squish area.

### C. Double oil filter

The oil system incorporates a fine mesh screen filter and a centrifugal filter to supply the engine with a highly clean oil. This minimizes the wear to the engine components, reducing maintenance and extending the life of the engine.

### D. Clutch

Right action clutch lever is employed on the S 90, CL 90, CL 90 L and CD 90, with automatic clutch installed on the C 90 and CT 90.

### E. Transmission

All speeds are constant meshed to provide smooth gear changes. The S 90, CL 90, CL 90 L and CT 90 have four forward speeds whereas the C 90 has three speeds. Further, the CT 90 is equipped with a posi-torque mechanism for selecting the low speed (1 $\frac{1}{2}$  reduction) range.

## 1.2 FRAME

### A. Rigid lightweight frame

The frame of the S 90, CL 90, CL 90 L and CD 90 are made of pressed steel sheet of monocoque design. Frame of the C 90 and CT 90 is a combination of pressed steel sheet with a large diameter steel pipe supporting the steering head. These designs give rigid lightweight frame of high strength.

### B. Rear suspension

Swing arm suspension is provided with a two stage cushion oil damper to provide comfortable riding under various loading and road conditions.

### C. Front suspension

Telescoping type front cushions are employed on the S 90, CL 90, CL 90 L and CT 90 models (from frame serial No. 000001A). Bottom link types are used on the C 90, CD 90 and CT 90 models (from frame serial No. 100001).

### D. Brake

Trailing leading type no fade brakes are used on both the front and rear wheels. The right handle lever operates the front brake and the right foot pedal operates the rear brake. The CT 90 is equipped in addition with a left hand lever to operate the rear brake.

## 2. SPECIFICATIONS AND PERFORMANCES

### 2.1 SPECIFICATIONS

Model Type	S 90	CL 90, CL 90 L
<b>Motorcycle Designation</b>	Honda 90	Honda 90
<b>Dimensions</b>		
Overall length	1,890 mm (74.47 in)	1,830 mm (72.1 in)
Overall width	650 mm (25.61 in)	810 mm (31.9 in)
Overall height	980 mm (38.61 in)	1,050 mm (41.3 in)
Wheelbase	1,195 mm (47.08 in)	1,200 mm (47.2 in)
Min ground clearance	145 mm (5.71 in)	160 mm (6.3 in)
<b>Weight</b>		
Weight Empty	86.5 kg (190.73 lbs)	92.0 kg (202.9 lbs)
Braking distance	Max. 7.0 m at 35 km/h (22.960 ft at 21.75 mile/h)	Max. 13 m at 50 km/h (47.6 ft @ 31 mile/h)
Fuel consumption	75 km/l at 40 km/h (176 mile/U. S. gal. @ 24.85 mile/h)	80 km/l at 40 km/h (188 mile/U.S. gal. @ 25 mile/h)
Climbing ability	18°	20°



CD 90	C 90	CT 90	CT 90 (from F. No. 000001A)
Honda 90	Honda 90	Honda 90	Honda 90
1,795 mm (70.72 in)	1,830 mm (72.10 in)	1,800 mm (70.92 in)	1,870 mm (73.6 in)
640 mm (25.22 in)	640 mm (25.22 in)	650 mm (25.61 in)	680 mm (26.8 in)
955 mm (37.63 in)	995 mm (39.20 in)	980 mm (38.61 in)	1,040 mm (41.0 in)
1,152 mm (45.39 in)	1,190 mm (46.89 in)	1,188 mm (46.81 in)	1,215 mm (47.9 in)
130 mm (5.12 in)	130 mm (5.12 in)	137 mm (5.40 in)	175 mm (6.9 in)
	85.0 kg (187.00 lbs)	81.5 kg (179.30 lbs)	91 kg (200 lbs)
Max. 6.75 m at 35 km/h (22.14 ft @ 21.75 mile/h)	Max. 6.9 m at 35 km/h (22.63 ft) (21.75 mile/h)	Max. 5.5 m at 30 km/h (18 ft) (19 mile/h)	Max. 5.5 m at 30 km/h (18 ft) (19 mile/h)
80 km/l at 35 km/h (188 mile/U.S. gal. @ 21.7 mile/h)	80 km/l at 30 km/h (188 mile/U.S. gal. @ 18.64 mile/h)	75 km/l at 40 km/h (176 mile/U.S. gal. @ 25 mile/h)	75 km/l at 40 km/h (176 mile/U.S. gal. @ 25 mile/h)
19°		High range 18° Low range 25°	High range 18° Low range 25°

Model Type	S 90	CL 90, CL 90 L
Min. turning radius	1,950 mm (76.830 in)	1,890 mm (74.4 in)
<b>Engine</b>		
Name and Model	Honda S 90 E	Honda CL 90 E
Type fuel used	Gasoline	Same as left
Type engine	Air cooled 4 stroke cycle	Same as left
No. of cylinder and arrangement	Single cylinder, tilted forward 75°	Same as left
Valve arrangement	Overhead valve	Same as left
Total piston displacement	89.6 cc (5.47 cu. in)	89.6 cc (5.47 cu. in)
Bore × Stroke	50 × 45 mm (1.97 × 1.77 in)	50 × 45.6 mm (1.97 × 1.80 in)
Compression ratio	8.2	8.2
Compression pressure	12 kg/cm <sup>2</sup> (170.676 lb/in <sup>2</sup> )	12 kg/cm <sup>2</sup> (170.676 lb/in <sup>2</sup> )
Max. output	8.0 PS/9500 rpm	CL 90 : 8.0 PS/9500 rpm CL 90 L : 4.9 PS/8000 rpm
Max. torque	0.65 kg-m/8000 rpm (4.701 lb. ft/8000 rpm)	CL 90 : 0.65 kg-m/8000 rpm (4.7 lb. ft/8000 rpm) CL 90 L : 1.97 kg-m/3500 rpm (14.24 lb. ft/3500 rpm)
Dimension	460 × 265 × 384 mm (18.12 × 10.44 × 15.13 in)	460 × 350 × 375 mm (18.12 × 13.85 × 14.76 in)
Total weight	23 kg (50.6 lb)	23 kg (50.6 lb)
Installation method	On frame center bolted from bottom	Same as left
Starting Method	Kick starter	Same as left
<b>Fuel System</b>		
Carburetor No. and type	PW 20 H (or UM 20 H), 1 each	Piston valve type, 1 each
Manufacturer	Keihin Seiki (Mikumi Kogyo)	Keiki Seiki
Air filter type	Dry filter element	Same as left
Manufacturer	Tokyo Roki	Same as left
Fuel tank capacity	7 l (14.80 U. S. pt.) (12.32 Imp. pt.)	7.5 l (15.9 U. S. pt.) (13.2 Imp. pt.)
<b>Lubrication System</b>		
Lubricating method	Pressure type	Pressure type
Type pump	Trochoid type	Trochoid type
Type oil filter	Screen and centrifugal filter	Same as left
Lubrication system capacity	0.9 l (1.90 U. S. pt.) (1.58 Imp. pt.)	0.9 l (1.90 U. S. pt.) (1.58 Imp. pt.)

CD 90	C 90	CT 90	CT 90 (from F. No. 000001A)
1,630 mm (64.22 in)	1,910 mm (75.25 in)	1900 mm (74.86 in)	1900 mm (74.86 in)
Honda CD 90 E	Honda C 90 E	Honda CT 90 E	Honda CT 90 E
Same as left	Same as left	Same as left	Same as left
Same as left	Same as left	Same as left	Same as left
Same as left	Same as left	Same as left	Same as left
Same as left	Same as left	Same as left	Same as left
89.6 cc (5.47 cu. in)	89.6 cc (5.47 cu. in)	89.6 cc (5.47 cu. in)	Same as left
50×45.6 mm (1.97×1.89 in)	50×45.6 mm (1.87×1.80 in)	50×45.6 mm (1.97×1.80 in)	Same as left
8.2	8.2	8.2	Same as left
12 kg/cm <sup>2</sup> (170.676 lb/in <sup>2</sup> )	12 kg/cm <sup>2</sup> (170.676 lb/in <sup>2</sup> )	12 kg/cm <sup>2</sup> (170.676 lb/in <sup>2</sup> )	Same as left
7.5 PS/9000 rpm	7.5 PS/9500 rpm	7.0 PS/8500 rpm	Same as left
0.72 kg-m/6000 rpm (5.21 lb. ft/6000 rpm)	0.67 kg-m/6000 rpm (4.846 lb. ft/6000 rpm)	0.69 kg-m/5000 rpm (4.991 lb. ft/6000 rpm)	Same as left
	350 g/PS-h/7000 rpm		
	505×280×345 mm (17.90×11.03×13.59 in)	550×280×345 mm (31.7×11.2×13.6 in)	
Same as left	24 kg (52.8 lbs)	24 kg (52.8 lbs)	25 kg (55 lbs)
Same as left	Same as left	Same as left	Same as left
Same as left	Same as left	Same as left	Same as left
Piston valve type, 1 each	PW 15 HAI, 1 each	Piston valve type, 1 each	Same as left
Keihin Seiki	Keihin Seiki	Keihin Seiki	Same as left
Same as left	Same as left	Same as left	
Same as left	Same as left	Same as left	
7.0 l (15.0 U. S. pt.) (12.3 Imp. pt.)	5.5 l (11.6 U. S. pt.) (9.7 Imp. pt.)	6.5 l (13.7 U. S. pt.) (11.4 Imp. pt.)	6.0 l (1.6 U. S. gal.) (1.3 Imp. gal.)
Pressure type	Pressure type	Pressure type	Same as left
Trochoid type	Trochoid type	Trochoid pump	Same as left
Same as left	Same as left	Same as left	Same as left
0.9 l (1.9 U. S. pt.) (1.6 Imp. pt.)	0.9 l (1.9 U. S. pt.) (1.6 Imp. pt.)	0.9 l (1.90 U. S. Pt.) (1.6 Imp. Pt.)	0.9 l (1.9 U. S. pt.) (1.6 Imp. pt.)

Model Type	S 90	CL 90, CL 90 L
<b>Ignition System</b>		
Ignition Method	Battery ignition	Same as left
Type Ignition Coil	SR 68 ..... 29700-101-0	ST 65 ..... 39700-101-0
Manufacturer	Kokusen Denki ..... Nihon Denso	Kokusen Denki ..... Nihon Denso
Type Spark Plug	D-6 HW	D-6 HS ..... X 20 FS
Manufacturer	NGK Spark Plug Co., Ltd.	NGK Spark Plug Co., Ltd. .... Nippon Denso
<b>Electrical System</b>		
Battery No. and type	MA 36 A or B 36-6, 1 each	Same as left
Volt and AH	6-6	6-6
Manufacturer	Yuasa Denki	Same as left
Type generator	37000-026-0 ..... EG 21	37000-026-0 ..... EG-26
Manufacturer	Nippon Denso ..... Kokusan Denki	Nippon Denso ..... Kokusan Denki
<b>Power Transmission System</b>		
Primary reduction method	Gear	Same as left
Reduction ratio	3.72	3.72
Clutch type	Wet multiple disc type	Same as left
Type transmission	Constant meshed gears	Same as left
Gear change method	Left foot operated return type	Same as left
Gear ratio, 1st gear	2.54	2.54
Gear ratio, 2nd gear	1.53	1.61
Gear ratio, 3rd gear	1.09	1.19
Gear ratio, 4th gear	0.88	0.96
Sub transmission		
Secondary reduction method	Chain	Same as left
Reduction ratio	3.21	3.21
<b>Steering System</b>		
Steering handle turning radius	43°	43°
Steering handle width	620 mm (24.428 in)	770 mm (30.3 in)
Caster	65°	64°
Trail	75 mm (2.955 in)	73 mm (2.87 in)
Tire, front	2.50-18 (4 PR)	2.50-18 (4 PR)
Tire, rear	2.50-18 (4 PR)	2.75-18 (4 PR)
<b>Brake System</b>		
Type brake, front	Internal expanding shoe	Same as left

CD 90	C 90	CT 90	CT 90 (from F. No. 000001A)
Same as left	Same as left	Same as left	Same as left
D-6 HS	ST 78	ST 79	Same as left
NGK Spark Plug Co., Ltd.	Kokusen Denki	Kokusen Denki	Same as left
ND X-20 FS	D-6 HW	D-8 HS	Same as left
Nippon Denso	NGK Spark Plug Co., Ltd.	NGK Spark Plug Co., Ltd.	Same as left
B 108-6, 1 each	B 37-6 A, 1 each	B 37-6 A, 1 each	Same as left
6-6	6-6	6-5.5	Same as left
Same as left	Same as left	Same as left	Same as left
		37000-055-0	Same as left
		Mippon Denso	Same as left
Same as left	Same as left	Same as left	Same as left
3.72	3.72	3.72	3.722
Same as left	Automatic wet multiple disc centrifugal type	Same as left	Same as left
Same as left	Same as left	Same as left	Same as left
Same as left	Same as left	Same as left	Same as left
2.54	2.538	2.538 (4.738*)	Same as left
1.61	1.555	1.611 (3.008*)	Same as left
1.19	1.000	1.190 (2.222*)	Same as left
0.96		0.958 (1.789*)	Same as left
		1.000 (1.867*)	Same as left
Same as left	Same as left	Same as left	Same as left
3.00	2.857	3.000	Same as left
43°	43°	45°	Same as left
640 mm (25.22 in)	630 mm (24.822 in)		
63.5°	63°	63.5°	Same as left
75 mm (2.955 in)	75 mm (2.955 in)	75 mm (2.955)	Same as left
2.50-17 (4 PR)	2.50-17 (4 PR)	2.50-17	2.75-17 (4 PR)
2.50-17 (4 PR)	2.50-17 (4 PR)	2.75-17	2.75-17 (4 PR)
Same as left	Same as left	Same as left	Same as left

Model Type	S 90	CL 90, CL 90 L
Type brake, rear	Internal expanding shoes	Same as left
Method of application, front	Right hand lever operated	Same as left
Method of application, rear	Right foot pedal operated	Same as left
<b>Suspension System</b>		
Suspension method, front	Telescopic type	Telescopic type
Suspension method, rear	Swing arm type	Same as left
Dampening system, front	Hydraulic	Same as left
Dampening system, rear	Hydraulic	Same as left
Frame Type	Backbone type	Same as left
<b>Lighting System</b>		
Headlight type	6-0109	
Manufacturer	Stanley Electric, Koito Seisakusho	Stanley Electric
Headlight rating	6 V—25/25 W	6 V—25/25 W
Taillight rating	6 V—2 W	6 V—5 W
Taillamp combination with	License light	Same as left
Stop light rating	6 V—6 W	6 V—17 W
Turn signal type	Magnetic, heating element	Same as left.
Turn signal rating	6 V—8 W	6 V—18 W
<b>Instrument</b>		
Horn type	Electric flat type	Same as left
Manufacturer		Mitsuba Denki
Speedometer Type	W/odometer	W/odometer
Manufacturer		Nippon Seiki
Reflex reflector type	RR 30 W/taillamp	RR 30 W/taillamp
Manufacturer	Stanley Electric	Same as left

CD 90	C 90	CT 90	CT 90 (from F. No. 000001A)
Same as left	Same as left	Same as left	Same as left
Same as left	Same as left	Same as left	Same as left
Same as left	Same as left	Right foot pedal and left hand lever operated	Same as left
Bottom link type	Same as left	Bottom link type	Telescopic Type
Same as left	Same as left	Same as left	Same as left
Same as left	Same as left	Same as left	Same as left
Same as left	Same as left	Same as left	Same as left
Same as left	Same as left	Same as left	Same as left
	ASS-11	ASS-11	Same as left
	Stanley Electric	Same as left	Same as left
6 V—25/25 W	6 V—25/25 W	6 V—25/25 W	Same as left
	6 V—3 W	6 V—5 W	Same as left
Same as left	Same as left	Same as left	Same as left
6 V—10 W	6 V—10 W	6 V—18 W	6 V—17 W
Same as left	Same as left		
6 V—10 W	6 V—8 W		6 V—18 W (option)
Same as left	Same as left	Same as left	Same as left
		Mitsuba Seiki or Nippon Denso	Same as left
	Magnetically driven	Same as left	Same as left
		Nihon Seiki or Nippon Denso	Same as left
	RR 30 W/taillamp	RR 30 W/taillamp	
	Same as left	Same as left	

## 2.2 PERFORMANCES

MODEL S 90





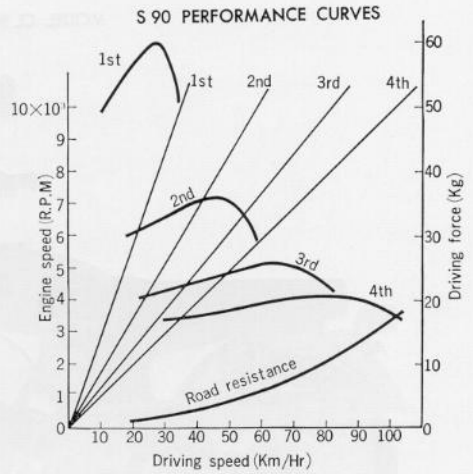

S 90 ENGINE PERFORMANCE

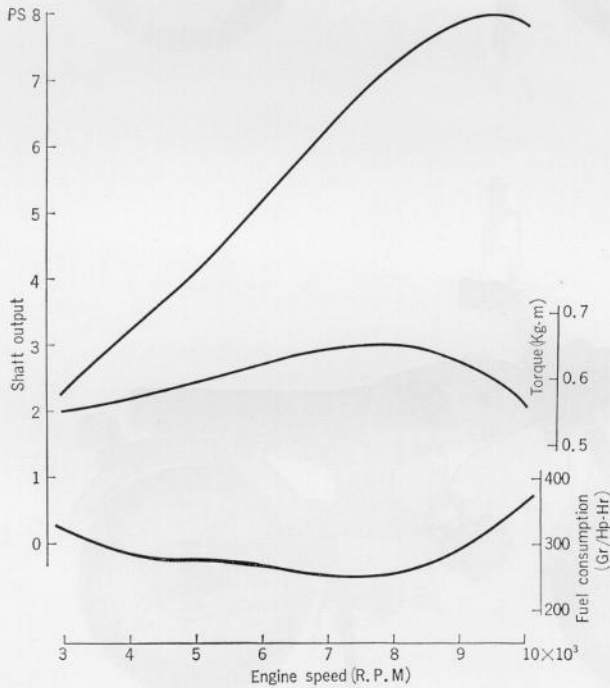

MODEL CL 90



CL 90 PERFORMANCE CURVES

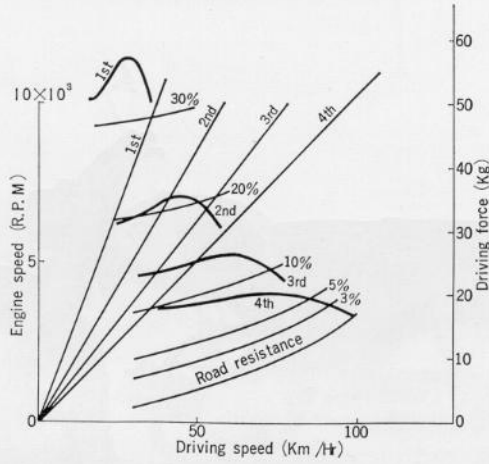

CL 90 ENGINE PERFORMANCE

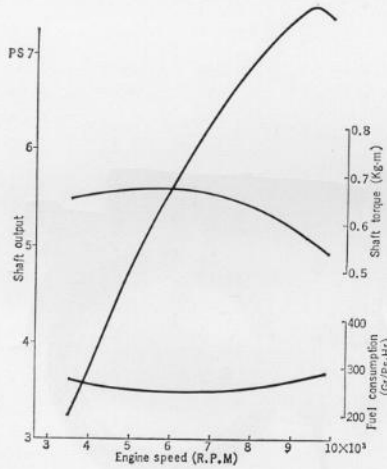

CL 90 L ENGINE PERFORMANCE

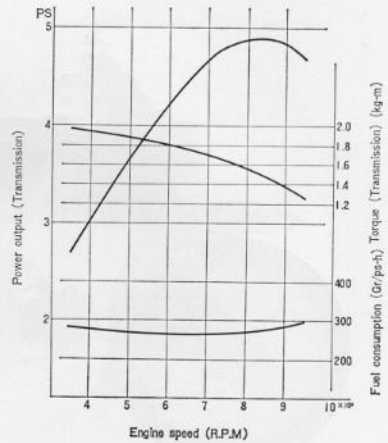

MODEL CD 90



CD 90 PERFORMANCE CURVES

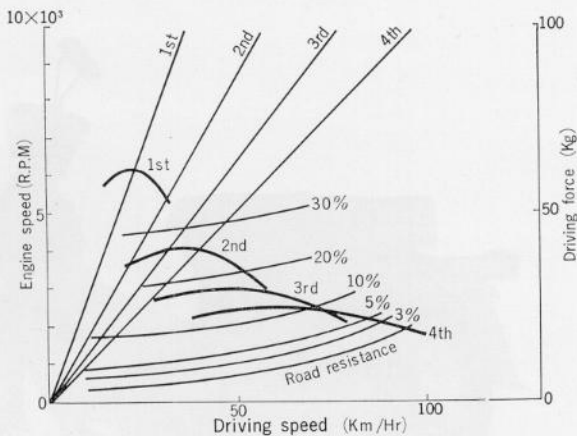

CD 90 ENGINE PERFORMANCE

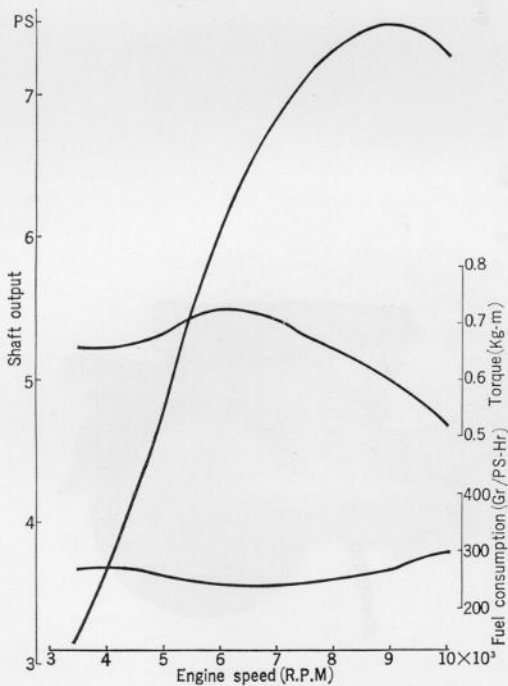

MODEL C 90



C 90 PERFORMANCE CURVES

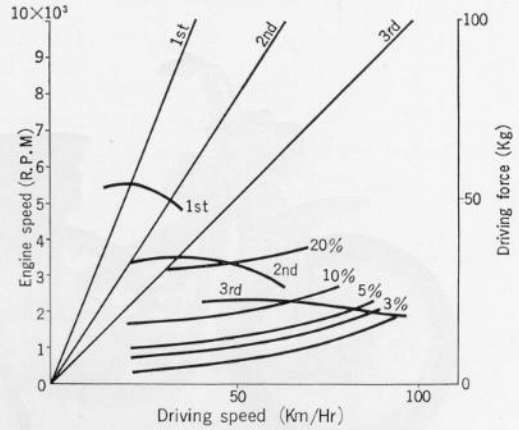

C 90 ENGINE PERFORMANCE

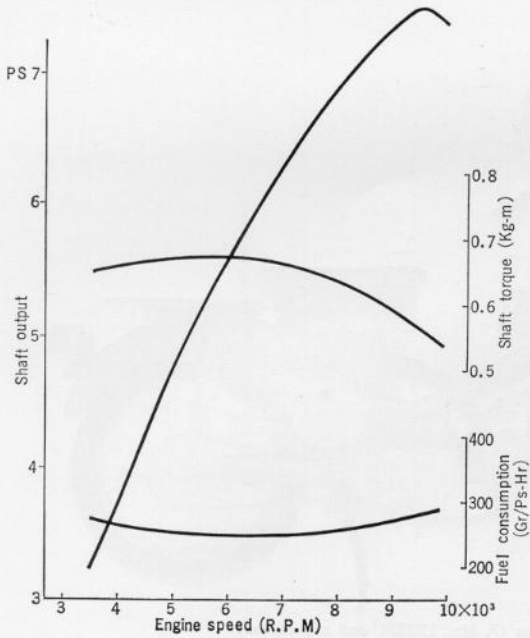

## MODEL CT 90



Prior to CT 90 F. No. 122550



Posi-torque (F. No. 122551 and subsequent)





Posi-torque (F. No. 00001A and subsequent)

CT 90 ENGINE PERFORMANCE

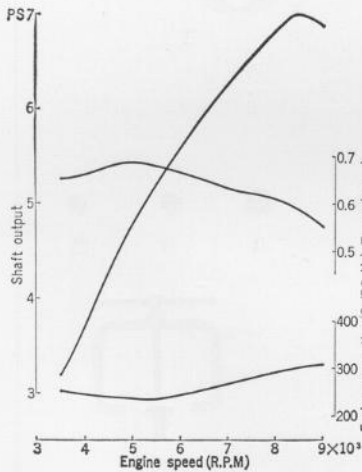

CT 90 PERFORMANCE CURVES

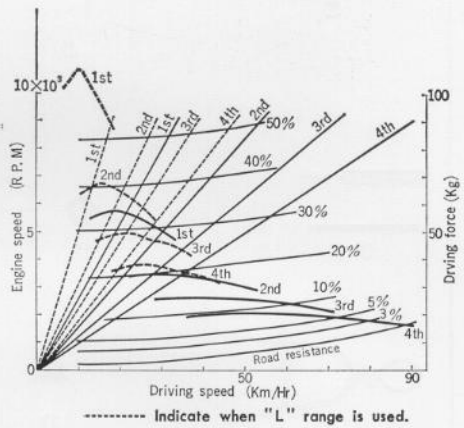

### 3. ENGINE

#### Tools Necessary for Disassembly and Reassembly

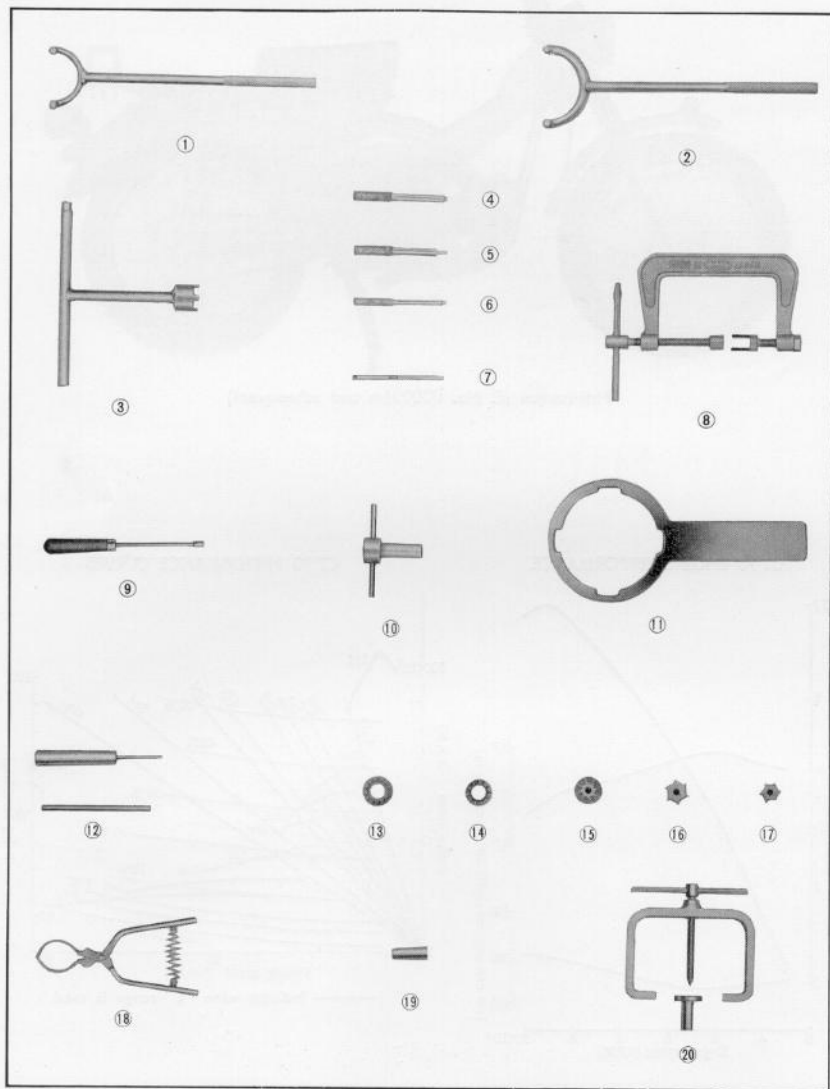

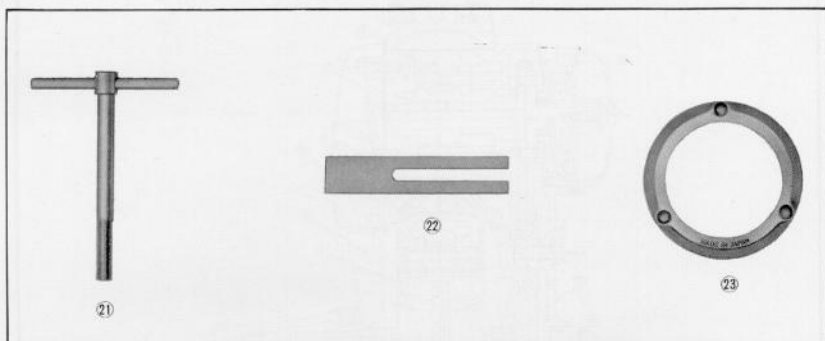

TOOL NO.	DESCRIPTIONS
① 07022-20001	Drive sprocket holder
② 07024-01101	Clutch outer holder
③ 07086-03001	T-handle box wrench, 16 mm
④ 07046-21601	Valve guide driver
⑤ 07047-04001	Valve guide remover
⑥ 07046-02801	Valve guide driver
⑦ 07008-00101	Valve guide reamer
⑧ 07031-20001	Valve lifter
⑨ 07081-00101	Tappet adjusting wrench
⑩ 07087-00101	Tappet lock nut socket wrench
⑪ 07024-03401	Clutch outer holder
⑫ 07007-02801	Valve seat cutter holder
⑬ 07003-02801	Inlet valve flat surface seat cutter
⑭ 07004-02801	Exhaust valve flat surface seat cutter
⑮ 07001-02801	Valve seat cutter, 90 degree
⑯ 07005-02801	Inlet valve interior seat cutter
⑰ 07006-02801	Exhaust valve interior seat cutter
⑱ 07032-03301	Piston ring compressor
⑲ 07057-03301	Oil seal guide
㉑ 07038-03301	Clutch disassembling & assembling tool
㉒ 07011-20001	Dynamo rotor puller
㉓ 07033-03301	Piston base
㉔ 07061-02801	Timing inspection cover

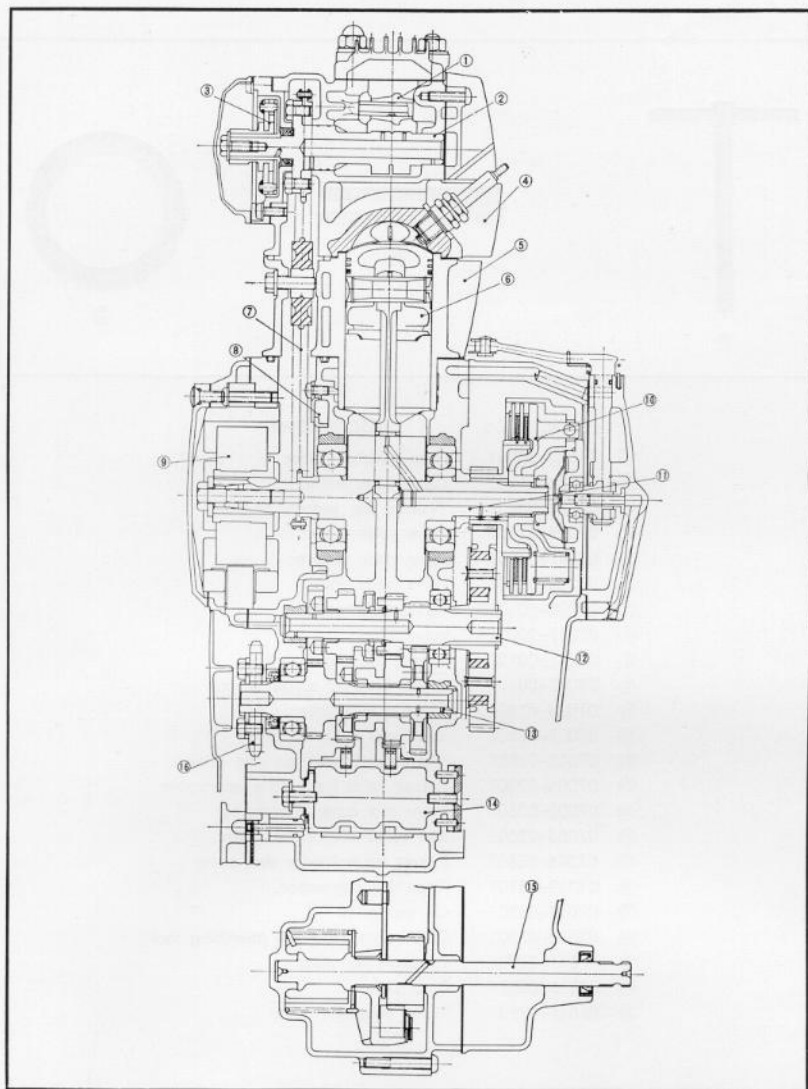

Fig. 3.1 Engine assembly diagram (S 90, CL 90, CL 90 L)

- |                       |                              |
|-----------------------|------------------------------|
| ① Valve rocker arm    | ⑩ A. C. generator rotor      |
| ② Cam shaft           | ⑪ Clutch assembly            |
| ③ Spark advancer      | ⑫ Crank shaft                |
| ④ Cylinder head       | ⑬ Transmission main shaft    |
| ⑤ Cylinder            | ⑭ Transmission counter shaft |
| ⑥ Piston              | ⑮ Gear shift drum            |
| ⑦ Cam chain           | ⑯ Kick starter spindle       |
| ⑧ Cam chain tensioner | ⑰ Drive sprocket             |

### 3.1 ENGINE DESCRIPTION

All of the models incorporate the O. H. C. design, driven from the left side of the engine by a light-weight endless chain. This provides the engine with high speed and high power output due to the elimination of the reciprocating movements and mechanical losses, and reduction in weight. Further the chain is always maintained in a constant tension by the oil pressure and spring operated automatic tensioner to assure quiet operation and precise valve timing at all speeds.

The lubrication system utilizes a trochoid type oil pump driven through the cam chain guide sprocket to provide lubrication under pressure to all of the primary moving parts of the engine and in conjunction, a screen and a centrifugal filter are incorporated in the system to assure that only highly purified oil is circulated within the engine to minimize the parts wear and attributing to the extended engine life.

(Fig. 3.1)

### 3.2 POWER TRANSMISSION SYSTEM

The energy produced by the combustion of the fuel mixture in the cylinder is applied to the top of the piston, this is transmitted to connecting rod → clutch drive plate → clutch outer → friction disc → clutch center → primary drive gear → primary driven gear → transmission main shaft → main shaft gear → counter shaft gear → counter shaft → drive sprocket → drive chain → driven sprocket → to the rear wheel, progressively in succession. (Fig. 3.2)

### 3.3 ENGINE REMOVAL

S 90, CL 90, CL 90 L, CD 90

1. Remove the step bar.
2. Remove the muffler.
3. Remove the left crankcase rear cover and unhook the drive chain from the sprocket.

(Fig. 3.3)

#### NOTE:

Tie a piece of wire to both ends of the chain to prevent the ends from being drawn into the chain case. This will facilitate the work during engine installation. (S 90, CD 90)

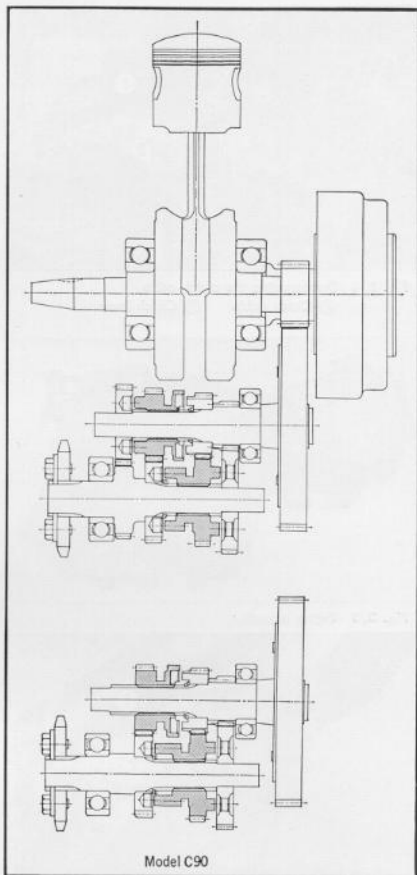

Fig. 3.2 Power transmission diagram

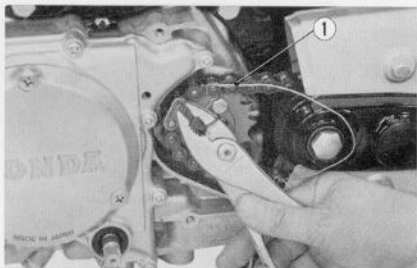

Fig. 3.3 Removing the drive chain  
① Drive chain

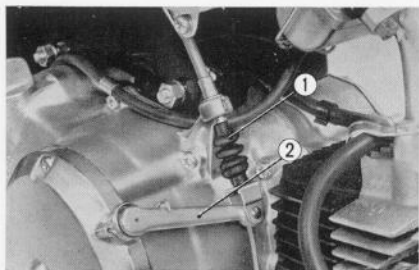

Fig. 3.4 Disconnecting the clutch cable  
① Clutch cable ② Clutch lever

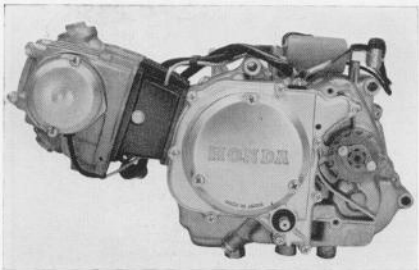

Fig. 3.5 Engine assembly

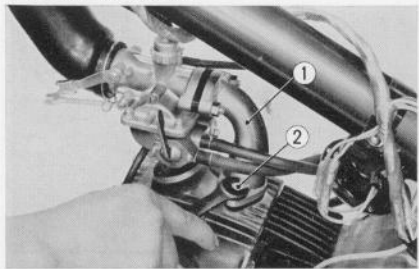

Fig. 3.6 Removing the inlet pipe  
① Inlet pipe ② Flange mounting bolt

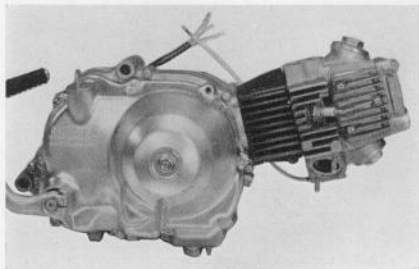

Fig. 3.7 Engine assembly (C90)

4. Disconnect the clutch cable ① from the clutch lever ②. (Fig. 3.4)
5. Disconnect the air inlet pipe at the cylinder head and also remove the high tension cord from the spark plug.
6. Remove the battery cover and disconnect the battery lead from the battery.

7. Unhook the brake pedal spring. Remove the nuts mounting the engine (3 for S 90, CL 90, CL 90L, 2 for CD 90) and the rear engine under bolt. Pull out the two 10 mm hex bolt, and the engine can be separated from the frame. (Fig. 3.5)

#### C 90, CT 90

1. Remove front cover (C 90), remove mudguard (CT 90). Remove the main pipe cover (CT 90 model from frame No. 000001A)
2. Remove the step bar.
3. Remove the left crankcase rear cover and remove the chain joint clip to disconnect the drive chain.

#### NOTE:

Tie a piece of wire to both ends of the chain to prevent the ends from being drawn into the chain case. This will facilitate the work during engine installation (C 90).

4. Remove the muffler.
5. Disconnect the air inlet pipe at the cylinder head. (Fig. 3.6)
6. Disconnect the electrical leads at the connectors.
7. Remove the high tension cord from the spark plug.
8. Unhook the brake pedal spring.
9. Remove the 2 engine mounting nuts and then pull out the rear engine under bolt and rear engine hanger bolt.
10. The engine can be removed. (Fig. 3.7)

### 3.4 ENGINE INSTALLATION

Generally, the engine installation is performed in the reverse order of removal.

1. Set the engine on a block and slide it under the frame.  
Route the engine wire harness up into the battery box where the engine and frame, and temporarily insert a screwdriver or a rod of appropriate diameter to suspend the engine.
2. Insert the engine mounting bolts from the left side, also replace the screwdriver and install and torque the nuts. Hook the brake arm return spring on the lower mounting bolt.
3. Connect all electrical leads to the wire harness.
4. Connect the battery leads to the battery terminals, push the wire bundle up into the top of the battery box where it will not interfere with battery installation. Install battery and check to make sure that the wires are not being pinched.
5. Route the battery vent tube through the floor of the battery compartment and make sure that the tube is not pinched or kinked, preventing proper venting.
6. Reconnect the clutch cable to the clutch lever.
7. Install the inlet pipe on the carburetor and bolt to the cylinder head. Install the high tension cable hold down clip under the right inlet pipe mounting bolt. Make sure that the O ring is installed between the cylinder head and inlet pipe.
8. Install the muffler.
9. Loop the drive chain over the drive sprocket and connect the chain. The open end of the chain joint clip must be installed facing in the opposite direction of the chain movement. (Fig. 3.8)
10. Install the chain case, the rear crankcase cover and the footrest bar.
11. Adjust the chain with the chain adjuster nuts on both sides of the rear wheel so that there is a slack of 1~2 cm (0.4~0.8 in) when checked with fingers on the bottom loop at mid-point between the sprockets. (Fig. 3.9)

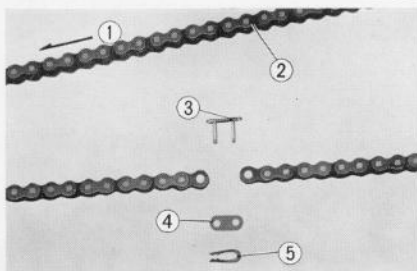

Fig. 3.8 Setting direction of chain clip

- ① Direction of rotation
- ② Drive chain
- ③ Chain joint
- ④ Chain joint ring plate
- ⑤ Chain joint clip

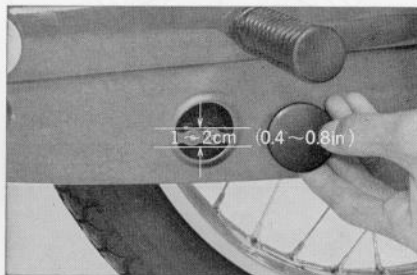

Fig. 3.9 Adjusting the chain

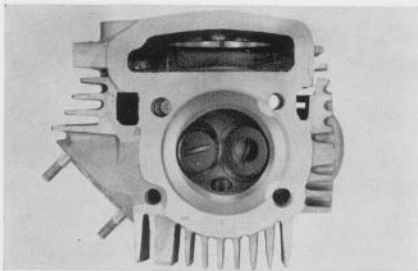

Fig. 3.10 Cylinder head

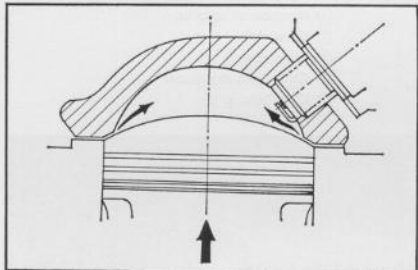

Fig. 3.11 Squish area

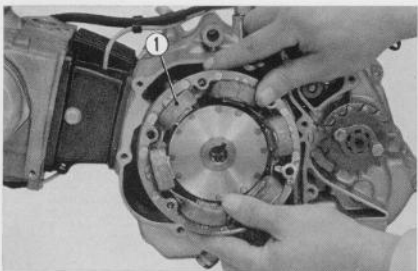

Fig. 3.12 Removing the stator assembly  
① Stator assembly

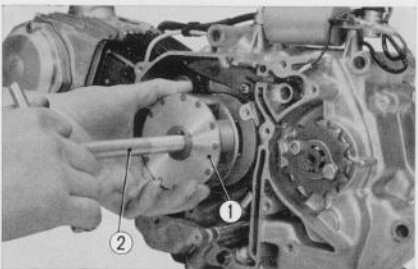

Fig. 3.13 Removing the rotor  
① Rotor ② Rotor puller

### 3.5 CYLINDER HEAD

#### A. Construction

The cylinder head is made of lightweight cast aluminum alloy for good heat dissipation and incorporates the camshaft, cam sprocket, valves, valve rocker arms, spark advancer and breaker assembly.

The overhead camshaft is driven by the cam chain through the cam sprocket. Combustion chamber is of semi spherical design for better cooling and increased combustion efficiency. (Fig. 3.10)

#### (Squish Area)

This is an area provided between the piston and cylinder head to further compress part of the fuel air mixture at the end of the compression stroke to create a turbulence of the main fuel mixture.

The swirling fuel mixture is directed toward the spark plug where it is ignited. The flame propagation is accelerated, allowing the leaner than normal fuel air ratio or the slower burning fuel mixture to burn smoothly, further, decreasing the tendency for knocking. (Fig. 3.11)

#### B. Disassembly (Cylinder Head Block)

1. Remove the point cover and then the left crankcase cover.

#### CAUTION:

Oil may flow out when removing the left crankcase cover.

2. Remove the stator assembly ①. (Fig. 3.12)

3. Remove the rotor ① using a dynamo rotor puller ② (Tool No. 07011-20001). (Fig. 3.13)

#### CAUTION:

When removing the rotor, caution not to apply excessive force so as to bend the crankshaft.



4. Remove the rocker arm side cover.
5. Remove the contact breaker assembly ① and disconnect the lead wire ②. (Fig. 3.14)

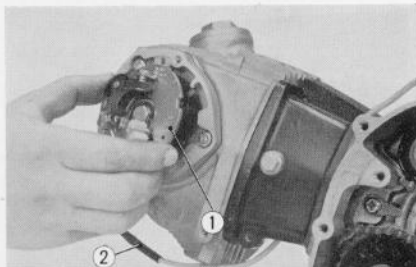

Fig. 3.14 Removing the contact breaker assembly  
① Contact breaker assembly ② Lead wire

6. Remove the spark advancer by removing the hex bolt and remove the  $3 \times 5.2$  dowel pin.
7. Remove the point base ① by taking off the three mounting screws. (Fig. 3.15)

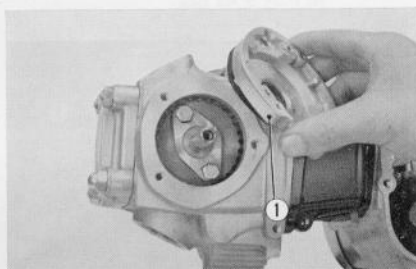

Fig. 3.15 Removing the point base ① Point base

8. Rotate the crankshaft so that woodruff key ① is aligned with the  $3 \times 5.2$  dowel pin hole in the camshaft and then remove the camshaft by unscrewing the two bolts. (Fig. 3.16)

**CAUTION:**

Perform the camshaft disassembly and assembly with the cylinder stud bolt nuts tightened.

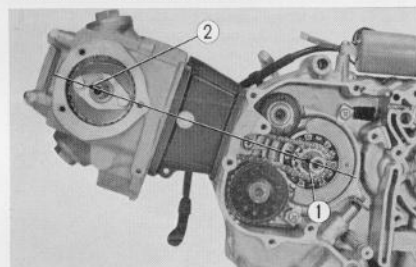

Fig. 3.16 Removing the camshaft  
① Woodruff key ② Dowel pin hole

9. Remove the cylinder head cover and the cylinder head. If the head is tight, tap around the parting surface of the cylinder head lightly with a soft face hammer.
10. Disassemble the valves using a valve lifter ① (Tool No. 07031-20001). (Fig. 3.17)

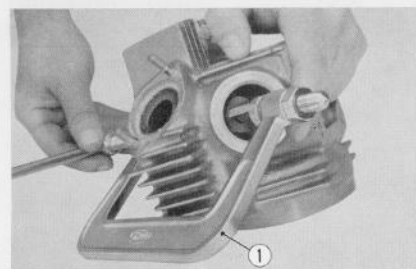

Fig. 3.17 Disassembling the valves ① Valve lifter

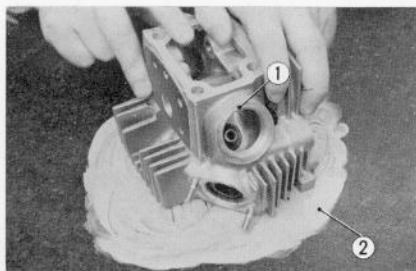

Fig. 3.18 Checking cylinder head warpage  
① Cylinder head  
② Bluing or red lead

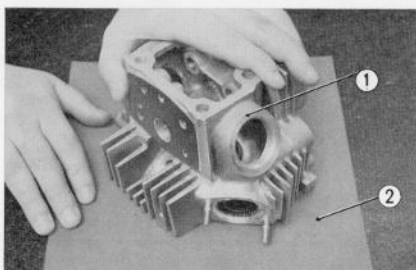

Fig. 3.19 Repairing warpage cylinder head  
① Cylinder head  
② Sand paper

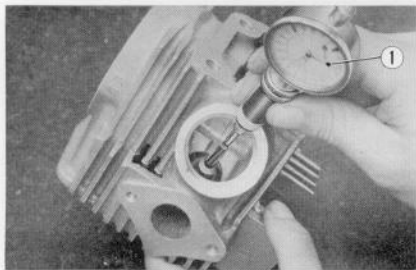

Fig. 3.20 Checking the valve guide diameter  
① Cylinder gauge

### C. Inspection and Repair

The cylinder head ① is exposed to the high pressure and temperature resulting from the combustion of the fuel mixture; further, when the cylinder head is unevenly torqued, it may develop cracks or warpage and will be the cause of defective sealing between the head and the cylinder and result in gas leak, air sucking, with consequent drop in compression.

The warpage of the cylinder head does not develop suddenly and it may be overlooked, therefore, caution should be exercised during reassembly since the uneven torquing of the cylinder head is a very common fault.

To inspect for warpage of the cylinder head ①, apply a thin coat of bluing or red lead ② on a surface plate and work the mating surface of the cylinder head on the surface plate; the warpage can be determined by the transfer of the bluing on to the cylinder head. (Fig. 3.18)

To correct the warpage, lap the cylinder head on the surface plate with a #200 sandpaper, finally finish by using a #400 sandpaper and then inspect again with the bluing. (Fig. 3.19)

1. Inspect the combustion chamber, inlet and exhaust ports for cracks.
2. Cylinder head combustion chamber.

Item	Standard value
Head volume (with the spark plug installed)	18~18.4 cc (1.098~1.122 cu. in)

3. Inspect the valve guide and valve stem.

Valve clearance	Standard value	Serviceable limit
Inlet	0.01~0.03 mm (0.0004~0.0012 in)	0.08 mm (0.0028 in)
Exhaust	0.03~0.05 mm (0.0012~0.0020 in)	0.1 mm (0.0032 in)

Check the valve guide diameter at the top, center and bottom in both the X and Y axes, using a precision cylinder gauge ①. Check the valve stem with a micrometer. (Fig. 3.20)

## 4. Inspect valve guide

Valve guide, inlet and exhaust	Standard value	Serviceable limit
Outside Dia.	10.055~10.065 (0.3962~0.3966 in)	—
Interference Fit	0.640~0.065 (0.0016~0.0026 in)	—
Inside Dia.	5.475~5.485 (0.2157~0.2161 in)	Replace if over 5.525 (0.2175 in)

If the valve guide inside diameter is beyond serviceable limits, it may be repaired by using a reamer ① and replacing the valve with one of an oversize. (Fig. 3.21)

5. When replacement of the valve guide becomes necessary, remove and replace with an oversize guide, use the valve guide remover (Tool No. 07047-04001) and the valve guide driver (Tool No. 07046-21601) for replacement operation. After installing the valve guide, use reamer to obtain the proper valve clearance. (Fig. 3.22)

## 6. Valve Seat

The condition of the valve seat plays a prominent roll in determining the performance of the engine, further, it serves as a means for dissipating the heat from the valves.

A valve seat in good condition should have a full surface contact with the valve face. Standard value ①—0.7~1.2 mm

(0.028~0.048 in)

Serviceable limit—in excess of 2 mm (0.08 in)

The valve seat contact can be checked by applying a thin coating of bluing or red lead evenly on the entire surface of the valve face and rotate the valve while holding it firmly against the valve seat. A good valve seating condition will show a uniform and continuous width of bluing on the valve seat.

Reworking of the valve, seat is performed by a set of three cutters ①. The 90° cutter is used for facing the valve contact area, and the location and width of the seat contact area is accomplished with the 60° and the 30° cutters.

Finally, the valve lapping operation is performed by lapping the ground valve face to the valve seat using a liberal amount of lapping compound on the valve face and work the valve back and forth using a suction cup lapping tool. Wash off the compound completely before making the test or before assembly. (Fig. 3.24)

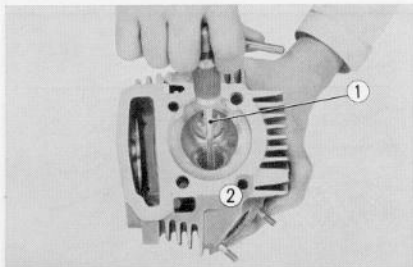

Fig. 3.21 ① Valve guide reamer ② Cylinder head

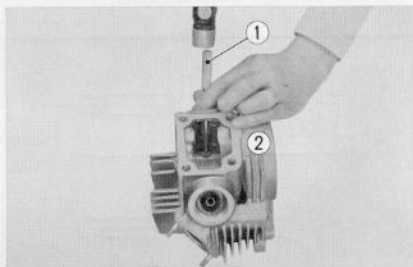

Fig. 3.22 ① Valve guide driver  
② Cylinder head

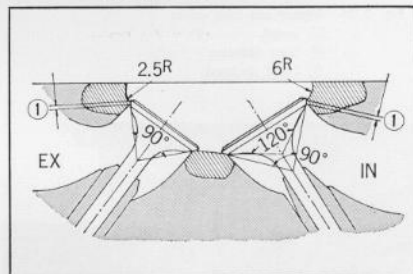

Fig. 3.23 Valve seat contact area  
① Valve seat contact width

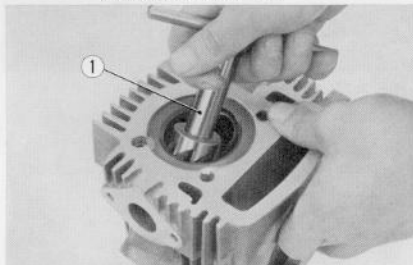

Fig. 3.24 Reworking the valve seat  
① Valve seat cutter

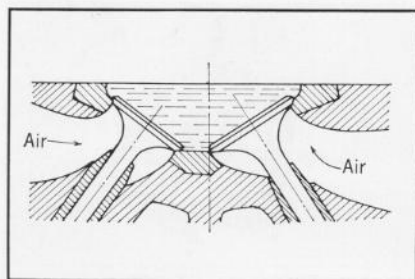

Fig. 3.25 Inspecting the valve seat contact

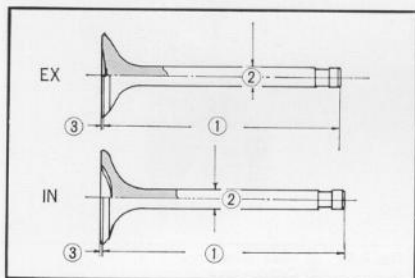

Fig. 3.26 Exhaust and inlet valves

- ① Length
- ② Stem diameter
- ③ Head thickness

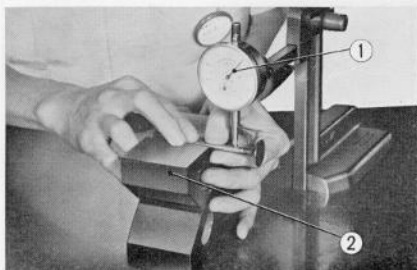

Fig. 3.27 Measuring valve

- ① Dial gauge
- ② V block

### 7. Inspection of valve sealing

Assemble the valve into the cylinder head as shown in Fig. 3.25 so that the valves are well seated and fill the cylinder head combustion chamber with oil, inject a blast of air  $2\text{kg}/\text{cm}^2$  (28.4 psi) in from the inlet and exhaust ports and if any bubbles should appear, it is an indication that the valve seats are not completely sealed. (Fig. 3.25)

(a) Exhaust valve (Fig. 3.26, 27)

Item	Standard value	Serviceable limit
Length ①	65.8~66.0 (2.593~2.600 in)	Replace if under 65.4 (2.577 in)
Stem dia ②	5.435~5.445 (0.2141~0.2145 in)	Replace if under 5.415 (0.2134 in)
Head thickness ③	0.6~0.8 (0.024~0.032 in)	Replace if under 0.3 (0.012 in)
Concentricity of valve face	0.02 TIR (0.0008 in)	Replace if over 0.03 (0.0012 in)

(b) Inlet valve (Fig. 3.26, 27)

Item	Standard value	Serviceable limit
Length ①	67.2~67.4 (2.648~2.654 in)	Replace if under 66.8 (2.632 in)
Stem dia ②	5.455~5.465 (0.2149~0.2153 in)	Replace if under 5.435 (0.2141 in)
Head thickness ③	0.6~0.8 (0.024~0.032 in)	Replace if under 0.3 (0.012 in)
Concentricity of valve face	0.02 TIR (0.0012 in)	Replace if over 0.03 (0.0012 in)

### Valve Mechanism

Both the inlet and exhaust valves are incorporated in the combustion chamber. The inlet valve is designed larger than the exhaust valve to afford greater volumetric efficiency. The exhaust valve is constantly exposed to extremely high temperature; therefore, it is made of special high heat resisting material to withstand the high temperature as well as the wear.

The cam chain revolves at a very high speed within the cam chain chamber which is located on the left side of the cylinder, making it necessary to use a heat resistant as well as a wear resistant rubber on the cam chain guide sprocket and cam chain tensioner roller to prevent chain noise. Further, in contrast to the conventional push rod type of a mechanism, this system has less reciprocating moving parts to cause hitting noises, making the operation

much smoother and quieter. It is very suitable for high speed to enable the increase in power output. (Fig. 3.28)

### 1. Valve Spring

Dual valve springs are used for extra strength and to prevent valve floating at high engine speed. They are arranged concentrically. The springs will require replacement if broken, deformed or have lost its strength.

#### (a) Outer valve spring (Fig. 3.29)

Item	Standard value	Serviceable limit
Free length	31.8 mm (1.253 in)	Replace if under 30.6 (1.207 in)
Spring pressure	27.8 mm/7.9~8.9 kg (1.095 in/17.38~19.58 lbs)	—
Spring pressure	22.3 mm/19~21 kg (0.879 in/41.8~46.2 lbs)	—
Tilt	—	Replace if over 1.5°

#### (b) Inner valve spring (Fig. 3.29)

Item	Standard value	Serviceable limit
Free length	26.5 mm (1.044 in)	Replace if under 25.5 (1.005 in)
Spring pressure	3.0~3.4 kg/23.9 mm (6.60~7.48 lbs/0.942 in)	—
Spring pressure	9.5~10.5 kg/18.4 mm (20.90~23.10 lbs/0.725 in)	—
Tilt	—	Replace if over 1.5°

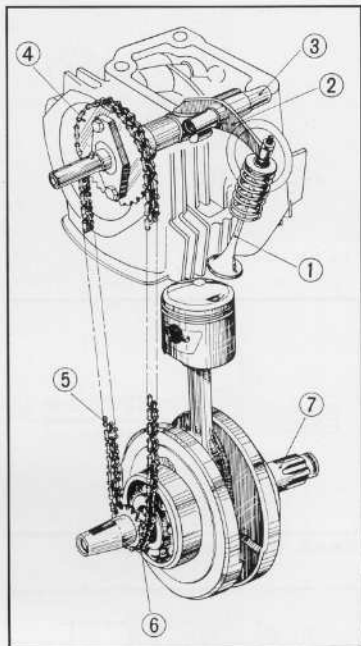

Fig. 3.28 Valve mechanism

- ① Valve
- ② Rocker arm
- ③ Rocker arm shaft
- ④ Cam sprocket
- ⑤ Cam chain
- ⑥ Timing sprocket
- ⑦ Crankshaft

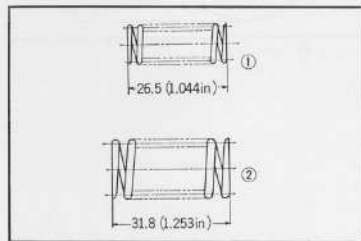

Fig. 3.29 Valve spring

- ① Inner spring
- ② Outer spring

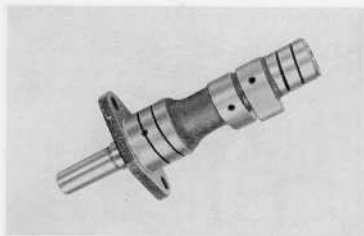

Fig. 3.30 Camshaft

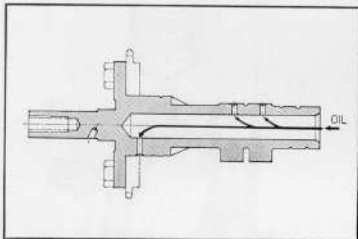
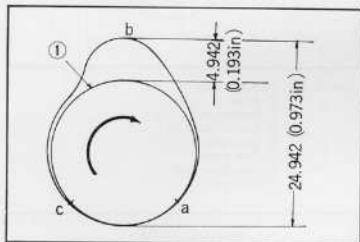

Fig. 3.31 Camshaft construction (Oil passage)

Fig. 3.32 Cam Contour  
① Base circle

## 2. Camshaft

In a four stroke cycle engine, the camshaft makes one revolution for every two revolutions of the crankshaft. The power to drive the camshaft is through the cam chain driven by the sprocket.

The lubricating oil is pressure-fed into the right side of the camshaft and is forced out of the holes in the cam to lubricate the cam surfaces, the rocker arms and the slippers. The camshaft is made of special cast steel with the cam and the bearing area being precisely ground after heat treatment. It is supported at both ends by the bearings in the cylinder head. A cam sprocket is installed on the left ends of the camshaft with 6 mm bolts and is driven at one half crankshaft speed by the timing sprocket press-fitted to the crankshaft end, through the light weight endless chain. (Fig. 3.30, 31)

The standard tappet clearances measured cold are 0.05 mm (0.002 in) for both the inlet and exhaust. This is the clearance measured when the rocker arm is against the heel of the cam lobe; in order to obtain this condition, the crankshaft must be rotated so that the "T" timing mark on the dynamo rotor is aligned with the timing mark on the stator; otherwise, the rocker arm may be on the lifting slope of the cam.

The opening and closing of the valve is determined by the piston stroke and is timed to the crankshaft rotation. During the inlet cycle, the inlet valve is opened and closed. During the exhaust cycle, the same opening and closing sequence takes place with the exhaust valve.

The open angle between the opening and closing is the same as the piston travel, however, since it is the same as the crankshaft rotation, it is expressed in terms of angular travels.

When point "a" in the Fig. 3.32 passes beyond the rocker arm, the vertical movement of the valve increases, and at a certain point where the cam lobe comes to a peak, the movement of the valve slows down and comes to a halt at point "b" on the cam.

The tappet clearance is adjusted when the rocker arm is at the exposed section of the heel of the cam between points "c" and "a".

## 1. Valve timing (Fig. 3.33)

Model	Inlet valve opens ①	Inlet valve closes ②	Exhaust valve opens ③	Exhaust valve closes ④
S 90	5° BTDC	35° ABDC	25° BBDC	5° ATDC
CL 90	5° BTDC	35° ABDC	25° BBDC	5° ATDC
CL90L	5° BTDC	20° ABDC	25° BBDC	5° ATDC
CD 90	5° BTDC	20° ABDC	25° BBDC	5° ATDC
C 90	5° BTDC	20° ABDC	25° BBDC	5° ATDC
CT 90	5° BTDC	20° ABDC	25° BBDC	5° ATDC

BTDC.....Before top dead center  
 ABDC.....After bottom dead center  
 BBDC.....Before bottom dead center  
 ATDC.....After top dead center

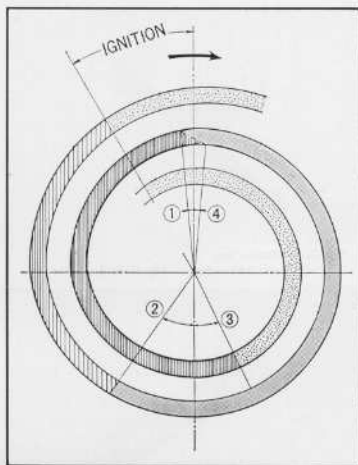

Fig. 3.33 Valve timing diagram

## 2. Camshaft (Fig. 3.34, 35)

Item	Standard value	Serviceable limit
Left end Dia (Fig. 3.35)	25.917~25.930 mm (1.0208~1.025)	Replace if under 25.180 (0.9913 in)
Right end Dia	17.927~17.939 mm (0.7060~0.6730)	Replace if under 17.900 (0.7147 in)
Shaft runout	0.01 max (0.0004 in)	Replace if over 0.05 (0.0020 in)
Cam height (Fig. 3.34)	24.90~24.98 mm (0.9792~0.9836 in)	Replace if under 24.6 (0.9684 in)
Left end bearing Dia	26.00~26.020 mm (1.0236~1.0244 in)	Replace if over 26.05 (1.0256 in)
Right end bearing Dia	18.000~18.018 mm (0.7086~0.7093 in)	Replace if over 18.05 (0.7106 in)

## 3. Cam sprocket root diameter

Standard value → 53.435~53.385  
 (2.103~2.105 in)

Serviceable limit → Replace if under  
 53.00 (2.09 in)

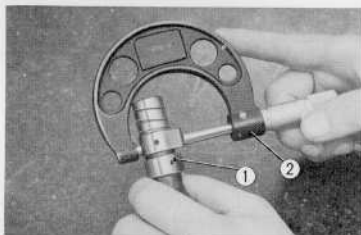
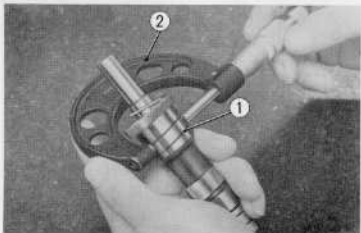
Fig. 3.34 Measuring camshaft height  
① Camshaft ② MicrometerFig. 3.35 Measuring camshaft end diameter  
① Camshaft ② Micrometer

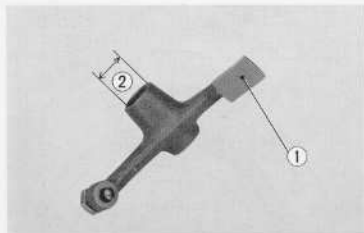

Fig. 3.36 Rocker arm  
① Slipper face ② Shaft bore

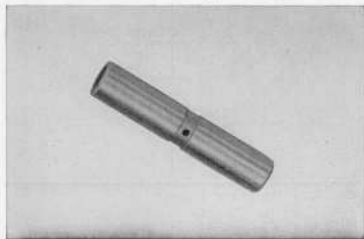

Fig. 3.37 Rocker arm shaft

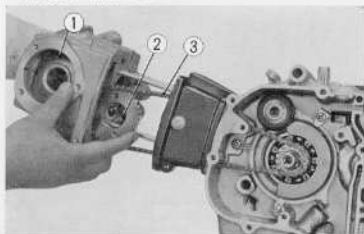

Fig. 3.38 Assembling the cylinder head  
① Cylinder head ② Cam sprocket ③ Cam chain

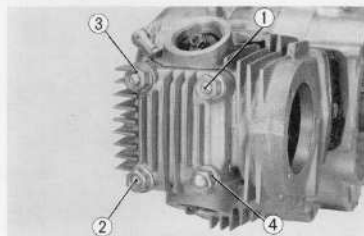

Fig. 3.39 Torquing sequence of cylinder head

#### 4. Rocker arm (Fig. 3.36)

Item	Standard value	Serviceable limit
Wear slipper	—	Replace if over 0.3 (6,0012 in)
Shaft bore	10.00~10.015 (0.3937~0.3943 in)	Replace if over 10.1 (0.40 in)

#### 5. Rocker arm shaft (Fig. 3.37)

Item	Standard value	Serviceable limit
Shaft dia	9.972~9.987 (0.3926~0.3933 in)	Replace if under 9.920 (0.3934 in)
Shaft clearance	0.013~0.043 (0.0005~0.0017 in)	Replace if over 0.08 (0.0031 in)

#### D. Reassembly

1. Apply engine oil to the valve stems before assembly into the cylinder head.
2. Assemble rocker arm and rocker arm shaft to the cylinder head and install rocker arm side cover.
3. Install the cylinder head. (Fig. 3.38)

##### NOTE:

Exercise care to make sure that the cylinder head gasket, cylinder stud gasket and cam chain gasket is installed properly to prevent oil leaks.

4. Install the cylinder head cover and tighten the nuts diagonally and uniformly to 150~200 kg·cm (14.5~18.1 lb·ft). Improper torquing will cause oil leak. (Fig. 3.39)



- Position the crankshaft so that the woodruff key ① is on the cylinder centerline and in the direction of the cylinder head. Align the "O" mark ② on the cam sprocket to the index mark on the cylinder head (the sprocket mounting bolt holes will be in line with the cylinder centerline) and then connect the cam chain ③. (Fig. 3.40)
- Slide the camshaft ① into the cylinder head through the sprocket ② with the pin hole toward the head cover.

The valve and the piston are in the top-dead center position of the compression stroke. (Fig. 3.41)

- Assemble the point base ① on the camshaft extension using an oil seal guide tool (Tool No. 07057-03301). (Fig. 3.42)

Damage to the oil seal may result if tool is not used, resulting in oil leak.

- Install the 3 × 5.2 guide pin and assemble the spark advancer.
- Assemble the contact breaker assembly and connect the leads.
- Assemble the A. C. generator on the crankshaft.
- Perform tappet clearance adjustment and ignition timing.
- Install the point cover and the left crankcase cover.

### 3.6 CYLINDER

#### A. Construction

The cylinder is made of special cast iron. The inside cylinder wall is exposed to high temperature and pressure together with the wearing action of the reciprocating piston operating at high speed to produce a great wearing effect. Added to this, the dust in the air and the foreign object and the metallic dust contaminating the oil will hasten the rate of wear, therefore, adequate attention should be given to the cleaning of the air filter and the oil change. (Fig. 3.43)

The piston receives the combustion energy and transmits the high reciprocating motion to the crankshaft where it is converted to the rotational motion.

Due to the high speed friction between the piston and cylinder, the selection of the materials and the tolerance of the moving parts must be selected with great care.

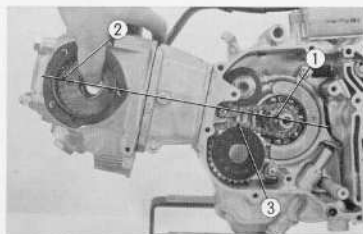

Fig. 3.40 Connecting the cam chain  
① Woodruff key ② "O" mark ③ Cam chain

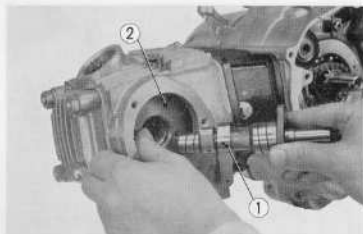

Fig. 3.41 Assembling the camshaft  
① Camshaft ② Cam sprocket

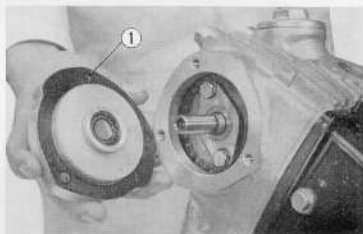

Fig. 3.42 Installing the point base ① Point base



Fig. 3.43 Cylinder

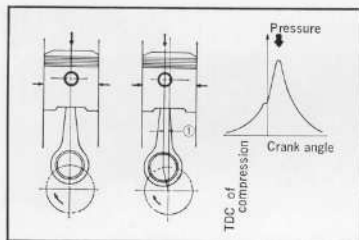

Fig. 3.44 Piston

Fig. 3.45 Cylinder offset  
① Offset

The piston is an aluminum casting made from select material. (Fig. 3.44)

This material is light and suitable for high speed, in addition to having good heat conducting property to dissipate the heat rapidly. Furthermore, the coefficient of heat expansion is small, thus minimizing the warpage at elevated temperature and permitting a small piston to cylinder clearance design. The shape of the piston is an elliptical taper. The head of the piston, compared to the skirt, is exposed to higher temperature and since the expansion is greater, it is tapered smaller toward the top. The tapering of the piston also tends to lessen the piston slap when the throttle is lightly snapped without the engine being loaded.

The piston employs a three step taper. The piston pin boss area is made thicker, thereby, resulting in greater expansion at high temperature. For this reason, the diameter of the piston skirt is made smaller in the direction of the piston pin so that at the high operating temperature, the piston will expand into a true circular shape. The skirt is constantly provided with flexibility to assure that no deformation will result even from extended continuous driving.

The piston pin is offset 1 mm (0.04in) from the piston centerline in the direction of the inlet side so that when the piston approaches the top-dead-center of the compression stroke, the side load from the cylinder moves from the right side to the left. With a "O" offset, the point will move to align with top-dead-center of the compression stroke. (Fig. 3.45)

As shown in Fig. 3.45, the point of maximum combustion pressure occurs after the top-dead-center, therefore, the purpose of the offset is to move the point toward the point of weaker pressure which is before top-dead-center, and by so doing, escapes the powerful pressure movement and makes it possible to eliminate the piston slap.

The piston ring performs a vital function of assuring proper combustion and transmission of the resultant force.

The top and second ring serve as a seal for the combustion chamber, the oil control ring scrapes the excess oil from the cylinder wall to control the cylinder wall lubrication. Further, they transmit the high temperature of the piston to the cylinder wall where it is dissipated out through the cylinder cooling fins.

For this reason, a special alloy of cast iron is used to provide strength, wear resistance, heat resistance, and good heat conducting properties and further it is given parkerizing treatment or ferrox coating.

The top ring especially is plated on the outer surface with hard chrome and finished by wet honing.

To prevent flutter, the thickness of the rings are made narrower and thicker. Inertia is made smaller to increase the pressure against the cylinder wall. Further the top and second rings are made at a slight taper where it contacts the cylinder wall so that the time required for wear-in is lessened.

(Fig. 3.46, 3.47)

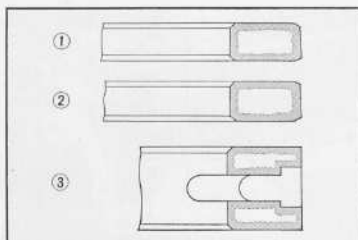

Fig. 3.46 Piston ring  
 ① Top compression ring  
 ② Second compression ring  
 ③ Oil ring

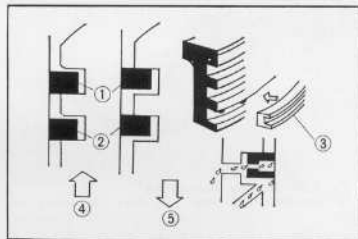

Fig. 3.47 Piston ring  
 Sealing and oil scraping function  
 ① Top compression ring  
 ② Second Compression ring  
 ③ Oil ring  
 ④ Sealing function  
 ⑤ Oil scraping

### B. Disassembly

1. Remove the cylinder head in accordance with section 3.5-B.
2. Remove the cam chain ② from the timing sprocket and remove the cylinder ① together with the chain. (Fig. 3.48)

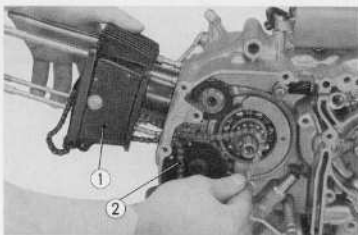

Fig. 3.48 Removing the cylinder  
 ① Cylinder  
 ② Cam chain

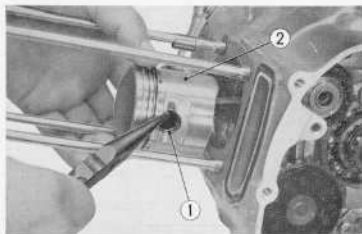

Fig. 3.49 Removing the piston pin  
① Piston pin clip ② Piston

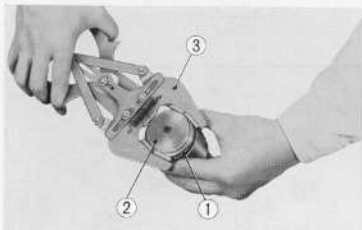

Fig. 3.50 Removing the piston ring  
① Piston ring ② Piston ③ Piston ring removing tool

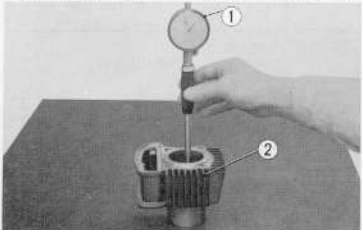

Fig. 3.51 Measuring the cylinder bore  
① Cylinder gauge ② Cylinder



Fig. 3.52 Measuring piston skirt diameter  
① Piston ② Micrometer

- The cam chain guide roller can be removed from the cylinder by removing the cam chain guide roller pin.
- Remove the piston pin clip ① and push out the piston pin to disassemble the piston from the connecting rod. (Fig. 3.49)

#### CAUTION:

When removing the piston pin clip, care should be exercised so that the clip does not drop into the crankcase.

- Remove the piston rings ① from the piston ② by using a ring removing tool (special tool) ③. If no tool is available, the rings may also be removed by hand, by spreading the ring at the opening with both hands, the ring should not be twisted. (Fig. 3.50)

### C. Inspection

- Measure the cylinder bore, taper, out-of-round with a precision cylinder gauge ①. Take the measurement at the top, middle and bottom in both the X and Y axes. (Fig. 3.51)

Item	Standard value	Serviceable limit
Cylinder taper	0.01 (0.0004 in)	Replace if over 0.05 (0.002 in)
Cylinder bore	50~50.01 (1.9685~1.9688 in)	Replace if over 50.1 (1.9739 in)
Surface roughness	1.5 micron	—

- The clearance between the piston and cylinder will greatly affect the engine performance. Because of the piston being elliptical, the clearance is controlled very closely. The clearances are not the same, however, if any area is greater than 0.1mm (0.004 in), the cylinder should be rebored and fitted with an oversize piston.

Oversize pistons are available in 0.25, 0.50, 0.75 and 1.00 mm (0.01, 0.02, 0.03 and 0.04 in) size.

- When removing carbon deposits from the piston top and ring grooves, care should be exercised so as not to cause any scratches or damages to the piston.
- Measure the skirt of the piston perpendicular to the piston pin hole. (Fig. 3.52)

Item	Standard value
Outside dia.	49.97~49.99 (1.9673~1.9681 in)

5. Measure the piston ring side clearance with a thickness gauge. (Fig. 3.53)

Item	Standard value	Serviceable limit
Piston ring side clearance	0.01~0.045 (0.0004~0.0181)	Replace if over 0.1 (0.004 in)

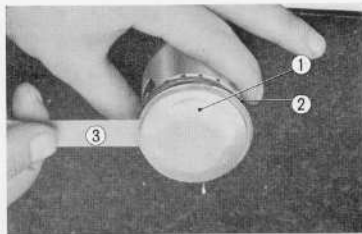

Fig. 3.53 Measuring the piston ring side clearance

- ① Piston  
② Piston ring  
③ Thickness gauge

6. Piston ring groove. (Fig. 3.54)

Item	Standard value	Serviceable limit
Bottom diameter ①	44.2~44.3 (1.740)~1.7441 in)	
Groove width (top and 2nd ring groove) ②	1.2~1.22 (0.0472~0.0480 in)	Replace if over 1.3 (0.0512 in)
Groove width (oil ring groove) ③	2.5~2.52 (0.0984~0.0992 in)	Replace if over 2.6 (0.1012 in)

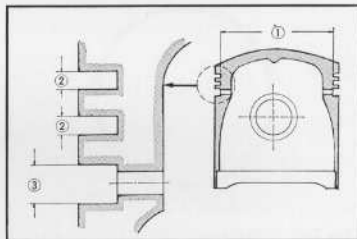

Fig. 3.54 Piston ring groove dimensions

7. Piston rings

Measure the ring end gap by inserting the ring (1) into the cylinder so that the ring is at right angle to the cylinder axis. (Fig. 3.55)

Item		Standard value	Serviceable limit
Ring thickness	1st & 2nd	1.175~1.190 (0.0808~0.0812 in)	Replace if under 1.13 (0.0445 in)
	Oil	2.475~2.490 (0.9743~0.9802 in)	Replace if under 2.43 (0.0953 in)
Ring closing force	1st & 2nd	0.63~0.84 kg (1.38~1.85 lbs)	Replace if under 0.4 kg (0.88 lbs)
	Oil	0.7~1.2 kg (1.54~2.64 lbs)	Replace if under 0.6 kg (1.32 lbs)
Ring end gap (Fig. 3.55)	1st & 2nd	0.15~0.35 (0.006~0.014 in)	Replace if over 0.5 (0.02 in)
	Oil	0.15~0.40 (0.0059~0.0157 in)	Replace if over 0.5 (0.020 in)

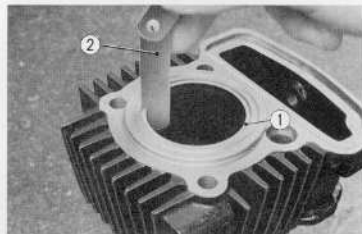

Fig. 3.55 Piston ring end gap

- ① Piston ring  
② Thickness gauge

**NOTE:**

1. Oversize piston rings are available in four sizes; 0.25, 0.50, 0.75 and 1.00 mm (0.01, 0.02, 0.03 and 0.04 in).

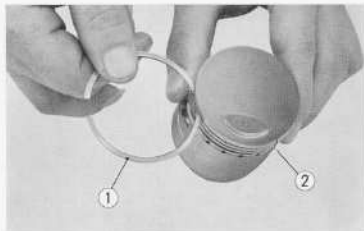

Fig. 3.56 Checking piston ring contact  
 ① Piston ring  
 ② Piston grooves

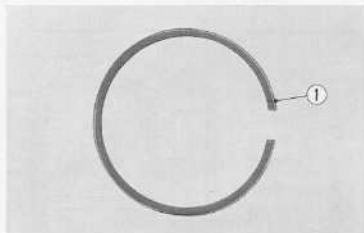

Fig. 3.57 Piston ring  
 ① Mark

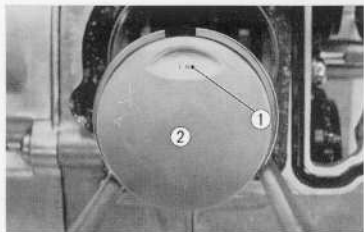

Fig. 3.58 Assembling the piston  
 ① "IN" mark  
 ② Piston

- When making piston ring end gap measurement, insert the ring carefully into the cylinder to prevent scratches or gouges to the cylinder wall.

#### D. Reassembly

- Install the piston rings on the piston in the same manner as it was removed. The bottom oil ring must be installed first.

##### CAUTION:

When new piston ring is installed, a check should be made to assure that the ring fits freely in the groove. This can be done by rolling the the piston ring ① externally in the piston groove ②. (Fig. 3.56)

The rings must not be installed upside down; this will cause oil pumping. The top side of the ring is etched at the end with the initial of the manufacture's name. (Fig. 3.57)

Use of the piston ring tool will facilitate installation and prevent possibility of ring breakage.

- Assemble the piston ① to the small end of the connecting rod, only a slight hand pressure should be required to insert the piston pin. Always install a new piston pin clips.

##### CAUTION:

The piston must be assembled so that the "IN" ① stamped on the piston head is toward the top when the engine is in the normal attitude. (Fig. 3.58)

- Assemble the cam chain and cam chain guide roller to the cylinder.
- Install the cylinder.

##### CAUTION:

The ring gap of the three piston rings should be staggered 120° apart.

Use of the piston ring compressor tool (Tool No. 07032~03301) for installing the cylinder will prevent damage to the piston ring and further, it will simplify the work.

Check to make sure that the cam chamber gasket is properly seated.

- Install the cylinder head in accordance with paragraph 3.5 D.

## 3.7 CAM CHAIN TENSIONER

## A. Construction

The camshaft is driven off of the drive sprocket on the crankshaft through the cam chain which is located on the left side and housed within the cam chain chamber. (Fig. 3.59)

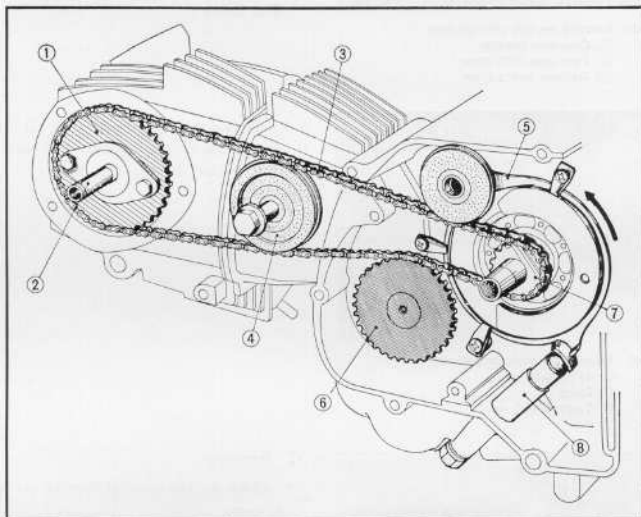

Fig. 3.59 Cam chain tensioner detail diagram

- |                                    |                            |
|------------------------------------|----------------------------|
| ① Cam sprocket                     | ⑤ Cam chain tensioner      |
| ② Cam shaft                        | ⑥ Cam chain guide sprocket |
| ③ Cam chain                        | ⑦ Timing sprocket          |
| ④ Cam chain guide roller tensioner | ⑧ Tensioner push rod       |

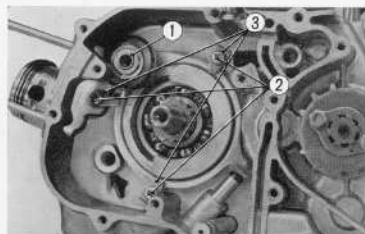

Fig. 3.60 Removing the cam chain tensioner  
 ① Cam chain tensioner  
 ② 5 mm cross point screw  
 ③ Tensioner setting plate

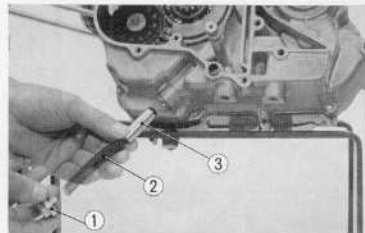

Fig. 3.61 Removing the tensioner push rod  
 ① 14 mm sealing plug  
 ② Spring  
 ③ Tensioner push rod

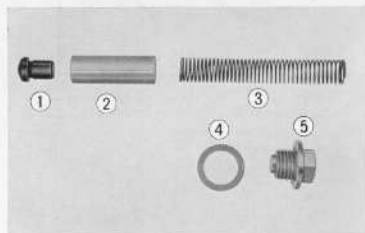

Fig. 3.62 Component parts of the cam chain tensioner  
 ① Tensioner cushion rubber  
 ② Tensioner push rod  
 ③ Tensioner spring  
 ④ 14 mm sealing washer  
 ⑤ 14 mm sealing plug

### B. Disassembly

1. Remove the A. C. generator in accordance with procedure described in section 3.5 B.
2. Remove the camshaft in accordance with the procedure described in section 3.5 B.
3. Remove the cam chain from the timing sprocket and then the cam chain guide sprocket.
4. Remove the cam chain tensioner ① by removing the three 5 mm screws ② attaching the cam chain tensioner setting plate ③ to the tensioner. (Fig. 3.60)

5. Unscrew the 14 mm sealing plug ① from the end of the tensioner pushrod and remove the spring ② and rod ③. (Fig. 3.61)

### C. Inspection

1. Check the cam chain tensioner for any damage or wear.

Item	Standard value	Serviceable limit
Tensioner spring free length	70.4 mm (2.772 in)	Replace if under 67.4 (2.654 in)
Spring tension	49 mm(55~81 g (1.931 in/2.275~ 2.835 oz.)	Replace if under 49 mm/40 g (1.931 in/1.400 oz.)

### D. Reassembly

1. Assemble the component parts in the reverse procedure as disassembly described in section 3.7 B.



### 3.8 CLUTCH

#### A. Construction

The function of the clutch is to temporarily disengage the transmitting of the rotary motion between the engine and the transmission during gear change and then after the gear change, permit a smooth power transition. The condition of the clutch will have a varying effect on the efficiency of the power transmission.

The clutch on all of the models are of the conventional wet type multiple disc. The C 90 and CT 90 models incorporate an automatic feature to operate the clutch engage and disengage function, whereas, the other models are provided manual functions.

#### Construction and Operation of Clutch

The clutch is between the engine body and the gear shift transmission. It connects or disconnects power transmission when required, such as in gear shifting, or starting the engine, etc.

Accordingly, such points as the degree of engagement accuracy, the ability to disengage completely, smoothness and slippage when engaged or disengaged, etc., become important.

[S 90, CL 90, CL 90 L, CD 90]

The clutch of the model S90, CL90, CL90L, CD90 is a wet multi-plate type. As shown in Fig. 3.63 A and Fig. 3.64, when the right crankcase cover is removed, the clutch outer portion is exposed. Inside, the clutch spring, drive plate, clutch plate, and clutch friction disc are assembled. The friction disc has teeth cut in its inner circumference, this portion fitting the spline cut in the external circumference of the drive gear, and is coupled into a unit with the drive gear in the direction of rotation. The drive gear is mounted on the crankshaft through the clutch center guide and can rotate freely on the crankshaft on the other hand, there are grooves cut in the interior of the drive plate to fit the spline cut at the tip of crankshaft; the drive plate is fastened to the crankshaft by a 16 mm lock nut, forming a single unit. Since, on the exterior of the drive plate and clutch plate, teeth engage the grooves cut in the interior of the clutch housing, the outer clutch, the drive plate, and the clutch plate rotate together with the crankshaft. Therefore, when the clutch is engaged,

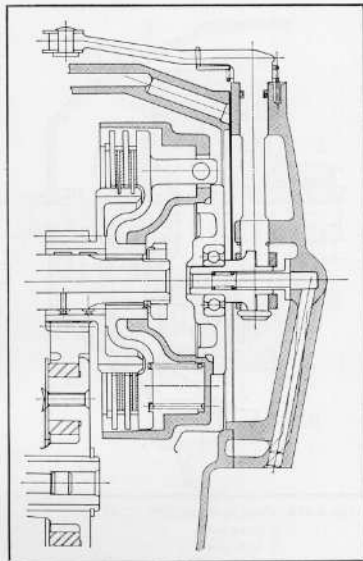

Fig. 3.63 A Clutch mechanism S 90, CL 90, CL 90 L, CD 90

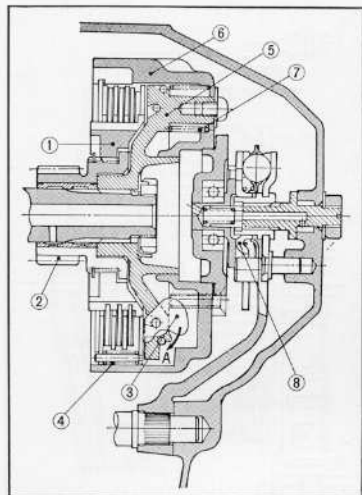

Fig. 3.63 B Clutch mechanism C 90, CT 90

- ① Clutch center
- ② Drive gear
- ③ Clutch weight
- ④ Clutch release spring
- ⑤ Drive plate
- ⑥ Clutch outer
- ⑦ Clutch spring
- ⑧ Clutch cam plate

the drive plate, clutch friction disc, and the clutch plate are held by the clutch spring forming a single unit by mutual friction and resulting in the transmission of the rotation of the crankshaft to the drive gear.

The drive gear is engaged with the driven gear and the power is conveyed to the transmission.

When the manual lever is gripped, the clutch disengage lever is rotated by the clutch cable. The clutch lifter arm, attached to the clutch lever, presses the clutch lifter by this rotational motion; the clutch lifter presses the clutch exterior through the clutch outer cover, reducing the force of the clutch spring to zero, and freeing the drive plate, clutch plate, and friction disc. Therefore, the rotation of the drive plate and clutch plate is not transmitted to the friction disc; the drive gear stops and power transmission is not performed. In addition, the clutch damper spring is installed sideways to prevent noise caused by idling in the direction of rotation of the drive plate and the clutch exterior, preventing damage to the teeth. [C 90, CT 90] (Fig. 3.63 B)

The clutch used on the C 90 and CT 90 is a wet type multiple disc, automatically operated by centrifugal force.

- Clutch center ① and drive gear ②

A screw spline is incorporated to engage the clutch during start and also to maintain the clutch engaged when using the engine compression for braking.

- Clutch weight ③ and release spring ④

When the clutch revolution attains a specified speed, the centrifugal force causes the clutch weights to move radially outward, to begin compressing the clutch release spring.

As the clutch speed increases, greater force is applied to the release spring, overriding the force of the release spring and permitting the clutch plate to engage with the friction disc, thus, permitting the power from the engine to be transmitted to the transmission and to the rear wheel.

The clutch release springs controls the minimum speed at which the engine output drives the rear wheel.

- Clutch shift mechanism

The drive plate ⑤ fixed to the crankshaft is the basic component of the clutch assembly. Clutch

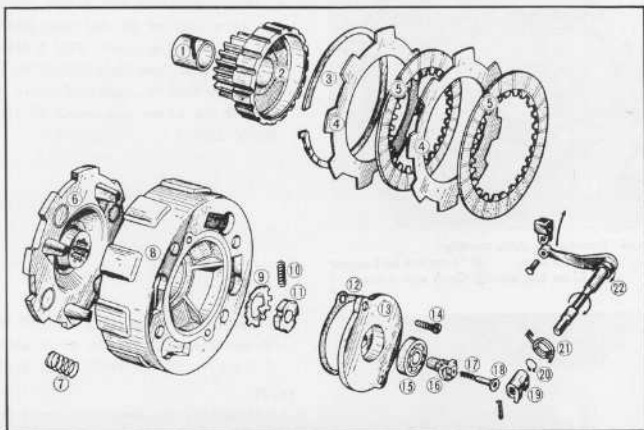

Fig. 3.64 Component parts of clutch, IS 90, CL 90, CL 90 L, CD 90)

- |                        |                             |
|------------------------|-----------------------------|
| ① Clutch center guide  | ⑫ Clutch outer cover gasket |
| ② Drive gear           | ⑬ Clutch outer cover        |
| ③ 102.5 mm set ring    | ⑭ 5 mm cross screw          |
| ④ Clutch plate         | ⑮ 6000 ball bearing         |
| ⑤ Friction disc        | ⑯ Clutch lifter             |
| ⑥ Drive plate          | ⑰ Oil through spring        |
| ⑦ Clutch spring        | ⑱ Oil through               |
| ⑧ Clutch outer         | ⑲ Clutch lifter arm         |
| ⑩ 16 mm lock washer    | ⑳ 10 mm strap ring          |
| ⑪ Clutch damper spring | ㉑ Clutch lever spring       |
| ⑰ 16 mm lock nut       | ㉒ Clutch lever              |

outer ⑥, which is assembled to the drive plate through the clutch spring ⑦, is operated by stepping on the gear change pedal.

By stepping on the gear change pedal, the clutch cam plate ⑧ is actuated, causing the pressure to be applied against the clutch outer and disengaging the clutch.

Since the change pedal is directly connected to the clutch cam plate, the clutch disengages before the gear change is effected, enabling gear changing to be performed smoothly both up and down without difficulty.

#### B. Disassembly

1. Remove the clutch cover.
2. Remove the right crankcase cover.
3. Remove the clutch outer cover. (Fig. 3.65)

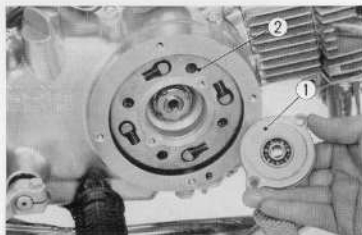
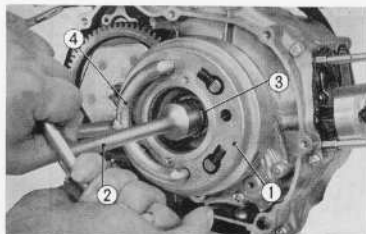

Fig. 3.65 Removing the clutch outer cover

- ① Clutch outer cover
- ② Clutch outer



**Fig. 3.66** Removing the clutch assembly  
 ① Clutch outer ② 16 mm lock nut T-spanner  
 ③ 16 mm lock nut ④ Clutch outer holder



**Fig. 3.67** Disassembling the clutch  
 ① Clutch disassembling and assembling tool  
 ② Clutch assembly

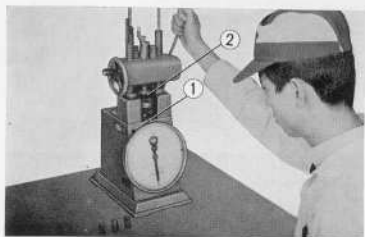

**Fig. 3.68** Inspecting the clutch spring  
 ① Spring tester ② Spring

4. Unlock the 16 mm lock washer and unscrew the 16 mm lock nut ③, the clutch assembly ① can be removed as a unit. (Fig. 3.66)

Use the clutch outer holder ④ (Tool No. 07024-01101) to hold the clutch and remove the lock nut with the 16 mm box wrench ② (Tool No. 07086-03001).

5. The work of disassembling the clutch assembly ② can be simplified by the use of special tool ① (Tool No. 07038-03001). (Fig. 3.67)

#### NOTE:

When using the special tool, avoid the drive plate, damper spring retainer, otherwise the drive plate cannot be compressed.

### C. Inspection

#### 1. Clutch spring (Fig. 3.68)

Item	Standard Value	Serviceable Limit
S 90	26.8mm	Replace if under 26.0 (1.0236 in)
CL 90	(1.0551 in)	
CL 90L	20.16~22.16 kg or 17.5mm	—
CD 90	(44.453~48.863 lbs or 0.6890 in)	
C 90	27.0	Replace if under 26.0 (1.0236 in)
	(1.0630 in)	
CT 90	10~10.4 kg at 15mm	—
	(22~22.9 lbs at 0.591 in)	

#### NOTE:

Use coil spring tester (Tool No. 07134-99901) for testing the valve spring tension.

## 2. Friction disc and clutch plate (Fig. 3.69)

Item	Standard value	Serviceable limit
Thickness of disc	2.6~2.9 mm (0.1102~0.1141 in)	2.4 mm (0.0944 in)
Thickness of clutch plate	1.93~2.07 mm (0.0760~0.0815 in)	Replace if under 1.85 mm (0.073 in)
Warpage of plate	0.2 mm (0.0079 in)	0.5 mm (0.0196 in)

## 3. Clutch outer and drive plate or clutch plate.

Item	Standard value	Serviceable limit
Backlash clutch plate	0.2 (0.008 in)	Replace if over 0.7 (0.036 in)
Backlash friction disc	0.2 (0.008 in)	Replace if over 0.7 (0.036 in)

## 4. Clutch center guide (Fig. 3.70)

Item	Standard value	Serviceable limit
Crankshaft to center guide clearance	0.005~0.047 mm (0.0002~0.0019 in)	Replace if over 0.15 (0.060 in)

## 5. Primary drive gear (Fig. 3.71)

Item	Standard value	Serviceable limit
Inside dia.	24.00~24.02 mm (0.945~0.946 in)	Replace if over 24.15 (0.951 in)
Chordal distance across 3 teeth	13.96~13.98 mm (0.5496~0.5504 in)	Replace if under 13.93 mm (0.5484 in)

## D. Reassembly

1. Into the clutch outer, assemble the clutch spring, drive plate, friction disc and clutch plates, and then compress the drive plate in accordance with the procedure in section 8-B-4 and install the set ring; also install clutch damper spring.
2. Assemble the drive gear, clutch center guide together with the clutch assembly on the crankshaft.

Torque the lock nut to 380~450 kg cm  
(54~64 lbs. ft)

## NOTE:

The lock washer ① must be locked by bending the tab after torquing the nut; if the side of the nut does not align with the tab, tighten the nut further to permit locking, do not loosen. (Fig. 3.72)

3. Assemble the clutch outer cover.
4. Install the right crankcase cover.
5. Install the clutch cover together with the clutch lifter and oil guide.

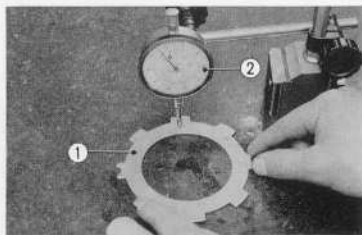

Fig. 3.69 Inspecting the clutch plate  
① Clutch plate ② Dial gauge



Fig. 3.70 Clutch center guide

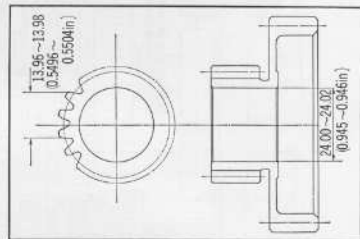

Fig. 3.71 Primary drive gear

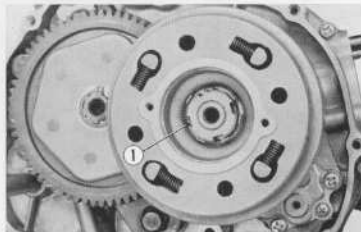

Fig. 3.72 Bend up tab of the lock washer  
① Lock washer

## 3.9 OIL PUMP

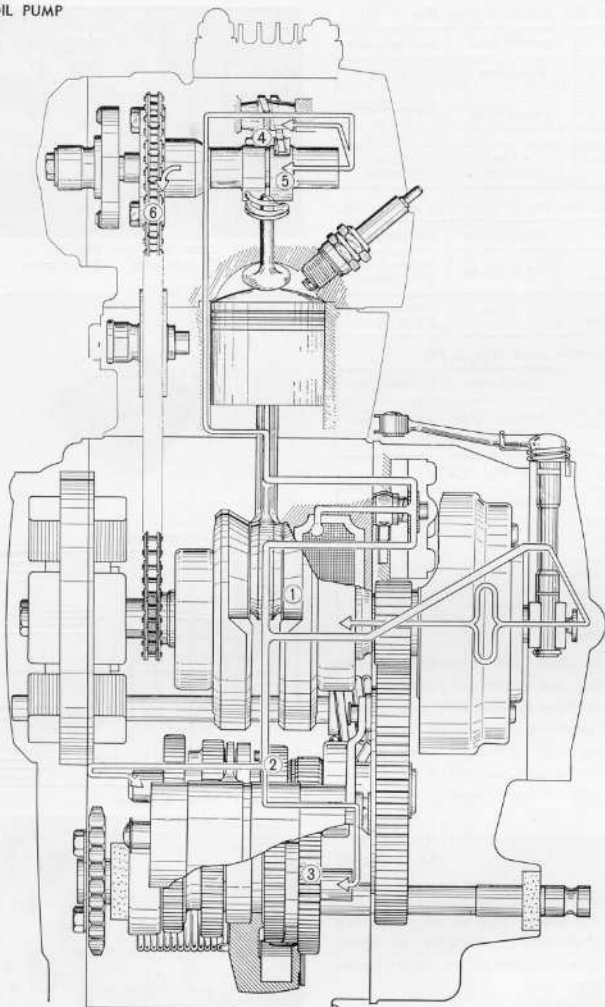

Fig. 3.73 Flow of lubricating oil

- |              |                          |                             |
|--------------|--------------------------|-----------------------------|
| ① Crankshaft | ② Transmission mainshaft | ⑤ Transmission countershaft |
| ④ Rocker arm | ③ Camshaft               | ⑥ Cam chain                 |

### A. Construction

The Honda 90cc motorcycle engine employs a gear type oil pump for the earlier models and trochoid type for the later models to furnish oil under pressure to all moving parts to prevent seizure and minimize wear. The oil which has been drawn up from the sump is passed through the strainer and is diverted in two directions.

One route: the oil is sent through the crankshaft ① and to the transmission where the component parts of the main shaft ② and the counter shaft ③ are lubricated.

The other route: the oil is piped through the passages in the right crankcase and the crankcase cover where it is further branched so that one of the route lubricates the crankshaft and component parts, and the other is routed to the hollow in the camshaft where the moving parts within the cylinder head such as the rocker arm ④, camshaft ⑤, and lubricates the cam chain ⑥ on its way back to the sump. The moving parts such as gears, bearings which are not lubricated by pressure are lubricated by oil splash and spray. (Fig. 3.73)

### B. Disassembly

1. Remove the clutch assembly as a unit in accordance with section 3.8B.
2. The oil pump can be removed by unscrewing the three 6mm screws ① and special hex bolt ②. (Fig. 3.74)

**NOTE:** All engines subsequent to the frame number shown below are equipped with a single piece right crankcase cover.

F. No. S 90-674103  
 CL 90-120015  
 C 201-168041 (CD 90)

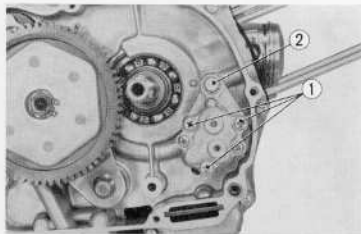

Fig. 3.74 A Gear oil pump  
 ① 6 mm cross screw  
 ② Special hex bolt

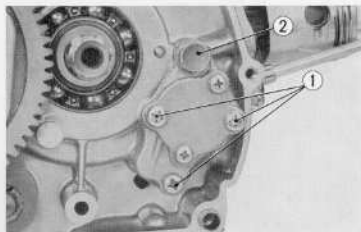
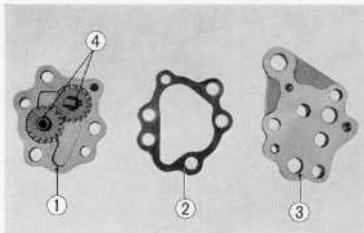
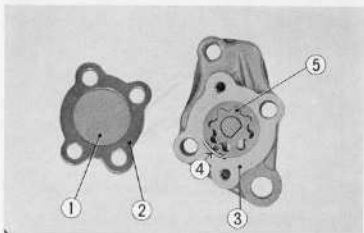

Fig. 3.74 B Trochoid oil pump  
 ① 6 mm cross screw  
 ② Special hex bolt



**Fig. 3.75 A** Gear oil pump  
 ① Oil pump cover  
 ② Oil pump cover gasket  
 ③ Oil pump body  
 ④ Oil pump gear



**Fig. 3.75 B** Trochoid oil pump  
 ① Oil pump cover  
 ② Oil pump cover gasket  
 ③ Oil pump body  
 ④ Outer rotor to pump body clearance  
 ⑤ Inner rotor

- The removal of the two 5mm screws will disassemble the oil pump. (Fig. 3.75)

### C. Inspection

- The normal capacity of the oil pump is 1200 cc (73.22 cu in)/minute @ 4000 rpm; if the capacity falls below 1000 cc (61.02 cu in), there is a danger of developing engine seizure, therefore, the pump should be repaired or replaced. [Trochoid pump: 1400 cc (85.43 cu in)/min @ 8000 rpm]
- Clearances of component parts

#### Gear Type

Item	Standard Value	Serviceable Limit
Gear to housing	0.05~0.09 (0.0020~0.0035 in)	Replace if over 0.15 (0.0059 in)
Gear backlash	0.0940~0.188 (0.0037~0.0074 in)	Replace if over 0.30 (0.0118 in)

#### Trochoid Type

Item	Standard Value	Serviceable Limit
Gear to housing	0.02~0.07 (0.0008~0.0028)	Replace if over 0.12 (0.0047 in)
Outer rotor pump body (A) (Fig. 3.75 B)	0.1~0.14 (0.0039~0.0055)	Replace if over 0.2 (0.0079 in)

### D. Reassembly

- Assemble the oil pump and install on to the right crankcase.
- Install the clutch assembly and the right crankcase cover in accordance with procedure outlined in section 3.8D.



## 3.10 GEAR SHIFT MECHANISM

## A. Construction

The gear shift fork is moved linearly by the rotary movement of the gear shift drum. When the gear shift pedal is depressed, the gear shift spindle, through the gear shift arm, causes the shift drum to move either in the clockwise or counter clockwise direction, depending upon whether the forward or

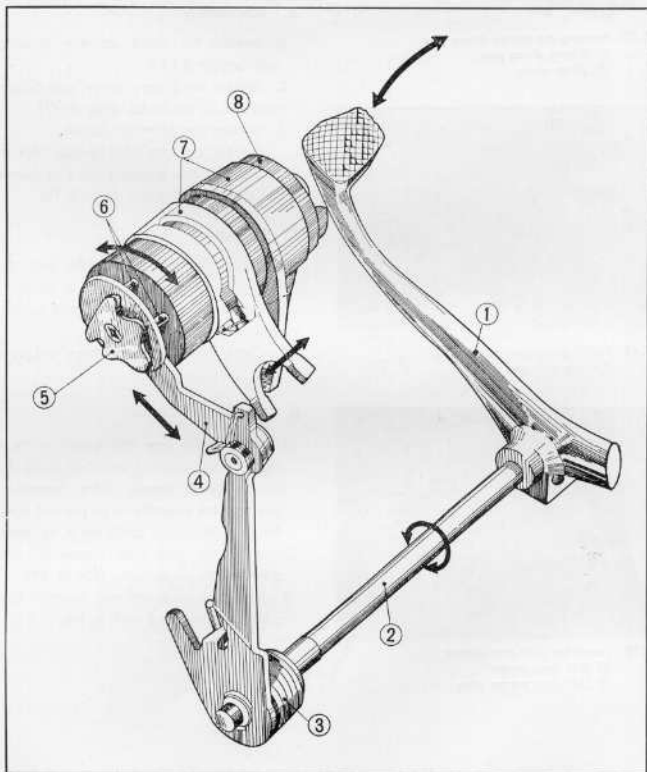

Fig. 3.76 Gear shift mechanism

- |                                |                                 |
|--------------------------------|---------------------------------|
| ① Gear change pedal            | ⑤ Gear shift drum stopper plate |
| ② Gear shift spindle           | ⑥ Gear shift drum pin           |
| ③ Gear shift arm return spring | ⑦ Gear shift fork               |
| ④ Gear shift arm               | ⑧ Gear shift drum               |

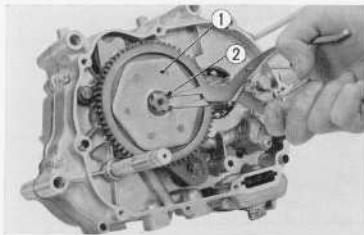

Fig. 3.77 Removing the primary driven gear  
 ① Primary driven gear  
 ② 20 mm circlip

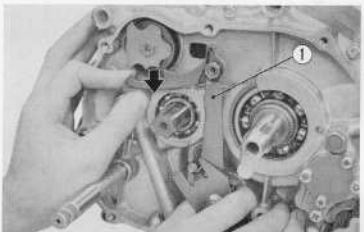

Fig. 3.78 Removing the gear shift spindle  
 ① Gear shift arm

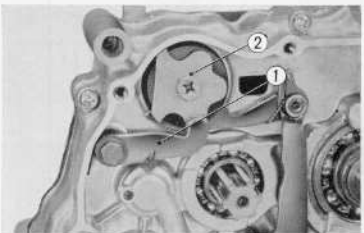

Fig. 3.79 Assembling shift drum stopper  
 ① Shift drum stopper  
 ② Shift drum stopper plate

rear of the pedal is depressed. The shift forks are fitted over the shift drum and guided in its linear movement by the cam groove on the surface of the shift drum into which the fork guide pins are inserted. Rotation of the drum shifts the forks to the right or left which in turn performs the gear shifting. A gear shift return spring returns the gear change pedal to its normal position after each gear change stroke. (Fig. 3.76)

#### B. Disassembly

1. Remove the clutch assembly in accordance with section 8.13 B.
2. Remove the primary driven gear ① by removing the 20 mm circlip. (Fig. 3.77)
3. Remove the shift drum stopper.

Pull out the gear shift spindle with the end of the shift arm engaging the shift drum held in the direction of arrow. (Fig. 3.78)

#### C. Inspection

1. Inspect the gear shift spindle, gear shift arm and gear shift forks for twist or bend.
2. Inspect the gear shift drum and guide pin for excessive wear.
3. Check the spring for breakage and proper tension.

#### D. Reassembly

1. Assemble the gear shift spindle in the reverse order of the sequence described in the disassembly section B above. After assembly, make sure that the operation is proper and also assure that the shift return spring pin is not bent.
2. Install the shift drum stopper ① and then assemble the driven gear. (Fig. 3.79)
3. Install the clutch unit and the right crankcase cover in accordance with section 3.8 D.

### 3.11 CRANKSHAFT

#### A. Construction

The crankshaft is constructed of high strength carbon steel and together with the connecting rod, converts the reciprocating motion of the piston to the rotary motion and, in addition, performs the function of the flywheel by absorbing the fluctuating torque.

The right and left crankshaft components are press fitted to the nickel chrome molybdenum crank pin with the connecting rod assembled.

The timing sprocket which drives the cam chain is shrunk fitted to the left crankshaft.

Crankshaft assembly is supported at two points by heavy duty ball bearings.

The right crankcase incorporates a center oil passage through which oil under pressure passes to the crankpin to lubricate the large end of the connecting rod. (Fig. 3.80)

#### B. Disassembly

1. Remove the clutch assembly in accordance with 8.B and the gear shift spindle in accordance with 10.B.
2. Remove the left crankcase.
3. Remove the cylinder head in accordance with 5.B and the cylinder in accordance with 6.B.
4. Remove the 6 × 16 hex bolt and separate the left crankcase.

The crankshaft and transmission will be completely exposed.

5. The crankshaft assembly ① can be removed from the left crankcase. ② (Fig. 3.81)

#### C. Inspection

1. Support the crankshaft ① on V blocks ③ at both bearings and measure the amount of runout. (Fig. 3.82)

Item		Standard value	Serviceable limit
Total runout	Left bearing web side at 35mm (1.379 in)	0.015 (0.0006 in)	Replace if over 0.110.004 in.
	Right bearing web side at 35mm (1.379 in)	0.015 (0.0006 in)	Replace if over 0.110.004 in.

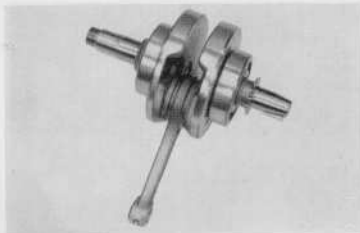

Fig. 3.80 Crankshaft

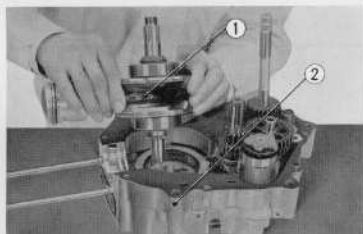

Fig. 3.81 Removing the crankshaft  
① Crankshaft  
② L. crankcase

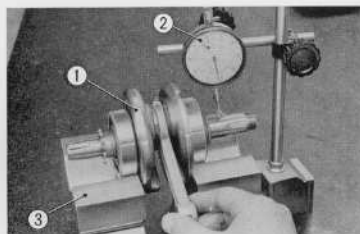

Fig. 3.82 Measuring crankshaft alignment  
① Crankshaft  
② Dial gauge  
③ V block

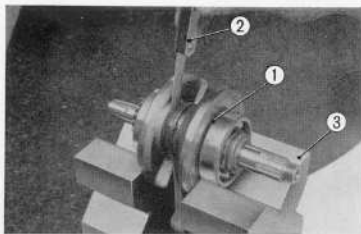

Fig. 3.83 Measuring axial clearance  
 ① Crankshaft  
 ② Thickness gauge  
 ③ V block

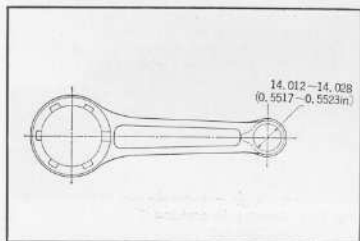

Fig. 3.84 Connecting rod

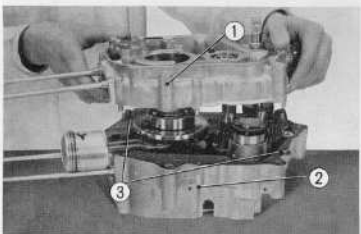

Fig. 3.85 Reassembling the crankcase  
 ① R. crankcase  
 ② L. crankcase  
 ③ Dowel pins

2. The clearance in the bearing is measured by fixing the crankshaft on centers and moving the bearing in the axial and vertical direction. (Fig. 3.83)

Item	Standard value	Serviceable limit
Axial clearance	0.10~0.35 (0.004~0.019 in)	Replace if over 0.8 (0.032 in)
Clearance normal to axis	0~0.01 (0~0.004 in)	Replace if over 0.05 (0.002 in)

When the clearance in the axial direction becomes excessive, the crankshaft will move from side to side when engine is running and produce undesirable noises as well as causing uneven wear to the cylinder, piston and the timing gear. It will also shorten the life of the clutch.

If the clearance is too small, it will cause a decrease in the power output and shorten the life of the crankshaft.

3. Connecting rod small end bore. (Fig. 3.84)  
 Standard value—14.012-14.028  
 (0.5517-0.5523 in)  
 Serviceable limit—Replace if over 14.05  
 (0.5531 in)

#### D. Reassembly

1. Assemble the crankshaft assembly into the left crankcase.
2. Assemble the right crankcase ① to the left crankcase, ② (Fig. 3.85)  
**Caution:** Do not forget to install the two dowel pins, ③ (Fig. 3.85)
3. Install the cam chain guide sprocket.
4. Assemble cylinder to the crankcase in accordance with section 3.6 D. and the cylinder head and cover in accordance with section 3.5 D.
5. Assemble the gear shift spindle in accordance with section 3.10 D. Assemble the clutch unit into the crankcase and install the right crankcase cover in accordance with section 3.8 D.

### 3.12 TRANSMISSION

#### A. Construction

The transmission receives the rotary power from the crankshaft and through a series of gears, changes it to the desired speed and then transmits it to the drive chain sprocket to drive the rear wheel.

The transmission on the S 90, CL 90, CL 90 L, CD 90 and CT 90 has four speeds. C 90 has three speeds. All the gears are constant-meshed, assuring smooth gear change. The later series transmission on the CT 90 is equipped with a sub-transmission which has a low speed range selectability, see section 3.15.

The primary reduction ratio for 90 cc: 3.722.

#### (Fig. 3.86)

1. Operation (S 90, CL 90, CL 90 L, CD 90 CT 90)

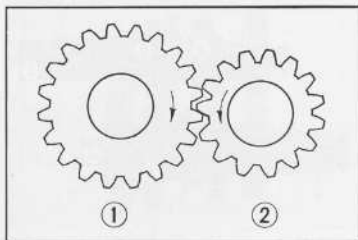

Fig. 3.86 Reduction and torque ratios

- ① Driven gear
- ② Drive gear

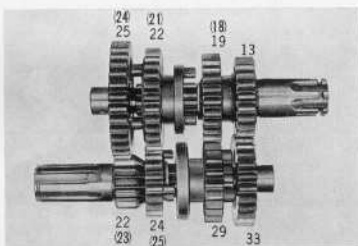

Fig. 3.87 Number of gear teeth, ( ) indicate CD 90

#### Low: (Fig. 3.88)

The power from the crankshaft is transmitted through the clutch to the spline fixed driven gear on the transmission main shaft. ①

The power from the transmission main shaft ① is transmitted from the main shaft drive gear to the freely rotating counter shaft low gear ③.

However, the counter shaft second gear ⑤ which is splined to the counter shaft and is moved against the low gear ④ by the shift fork and is locked by means of a dog, forming an integral unit with the countershaft to transmit the driving force to the drive sprocket mounted on the left end of the counter shaft.

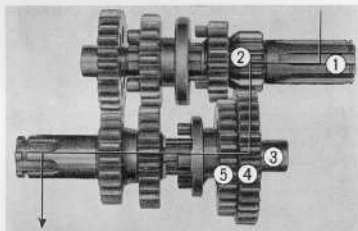
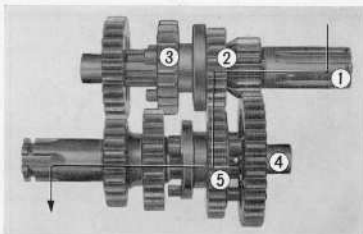
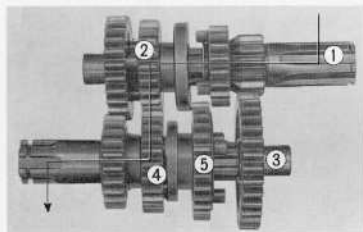

Fig. 3.88 Low gear

- ① Transmission mainshaft
- ② Low gear
- ③ Transmission countershaft
- ④ Countershaft low gear
- ⑤ Countershaft second gear



**Fig. 3.89** Second gear  
 ① Transmission mainshaft  
 ② Mainshaft second gear  
 ③ Mainshaft third gear  
 ④ Transmission countershaft  
 ⑤ Countershaft second gear



**Fig. 3.90** Third gear  
 ① Transmission mainshaft  
 ② Mainshaft third gear  
 ③ Transmission countershaft  
 ④ Countershaft third gear  
 ⑤ Countershaft second gear

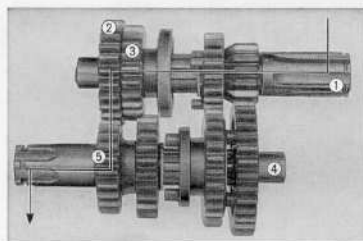

**Fig. 3.91** Top gear  
 ① Transmission mainshaft  
 ② Mainshaft top gear  
 ③ Mainshaft third gear  
 ④ Transmission countershaft  
 ⑤ Top gear

#### Second : (Fig. 3.89)

The main shaft third gear ③ which is spline slide fitted to the main shaft ① is moved by the shift fork to lock with the second gear ② by means of a dog, thus permitting the transmission of power from the main shaft to the counter shaft ④, by meshing the main shaft second gear with the splined counter shaft second gear ⑤ hence to drive the sprocket.

#### Third : (Fig. 3.90)

The power from the transmission main shaft ① is transmitted to the counter shaft third gear ④ by meshing with the main shaft third gear ②. The counter shaft second gear ⑤ which is spline slide fitted is moved by the shift fork to lock with the free rotating third gear ④ by means of a dog, this causes the counter shaft ③ to rotate and in turn drives the sprocket.

#### Top : (Fig. 3.91)

The main shaft third gear ③ is moved by the shift fork to lock with the free rotating top gear ② by means of a dog, thus permitting the transmission of power from the main shaft ① to the counter shaft by meshing the main shaft top gear ② with the fixed counter shaft to drive the sprocket.

**Neutral : (Fig. 3.92)**

The gears are not locked. The main shaft low gear ① is meshed with the counter shaft low gear ② and the main shaft third gear ③ is meshed with counter shaft third gear ④, however, the counter shaft gears rotate freely and therefore no power is delivered to the drive sprocket.

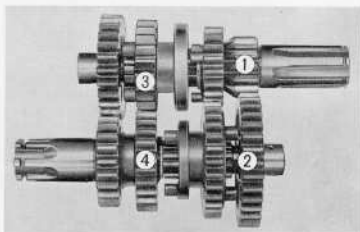

Fig. 3.92 Neutral

**2. Operation (C 90)****Low : (Fig. 3.93)**

The power from the crankshaft is transmitted through the clutch to the spline fixed driven gear ① on the transmission main shaft ②. The power from the transmission main shaft is transmitted from the main shaft driven gear to the freely counter shaft low gear ③. However, the counter shaft second gear ④ which is splined to the counter shaft and is moved against the low gear by the shift fork and is locked by means of a dog, forming an integral unit with the counter shaft ⑤ to transmit the driving force to the drive sprocket ⑥ mounted on the left end of the counter shaft.

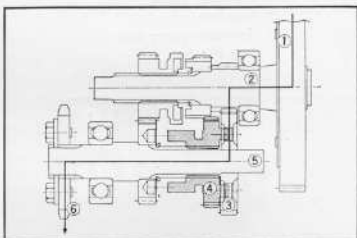

Fig. 3.93 Low gear

**Second : (Fig. 3.94)**

The main shaft top gear ③ is moved by the shift fork to lock with the free rotating second gear ② by means of a dog, thus permitting the transmission of power from the main shaft ① to the counter shaft ④ by meshing the main shaft second gear ② with the counter shaft second gear ⑤ to drive the sprocket.

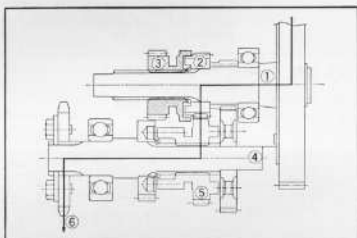

Fig. 3.94 Second gear

**Top : (Fig. 3.95)**

The counter shaft second gear ④ is moved by the shift fork to engage the top gear ③ by means of a dog. The power is transmitted from the main shaft top gear ② and to the counter shaft top gear ③ and to the drive sprocket.

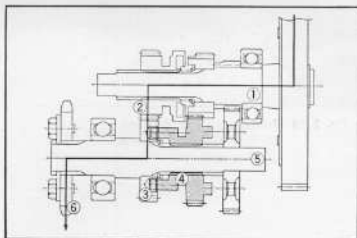
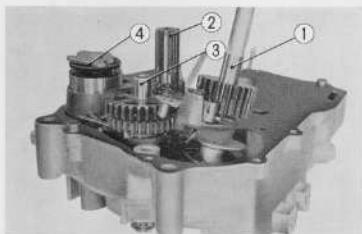
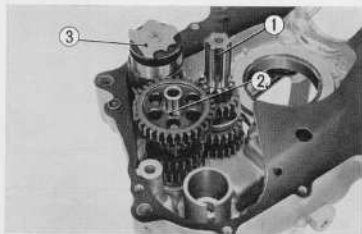

Fig. 3.95 Top gear



**Fig. 3.96** Removing the kick starter spindle  
 ① Kick starter spindle  
 ② Transmission main shaft  
 ③ Transmission counter shaft  
 ④ Gear shift drum



**Fig. 3.97** Removing the gears  
 ① Transmission main shaft  
 ② Transmission counter shaft  
 ③ Gear shift drum

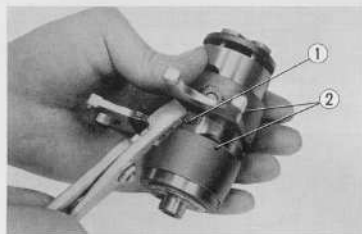

**Fig. 3.98** Removing the gear shift fork  
 ① Gear shift guide pin clip  
 ② Gear shift fork

### B. Disassembly

1. Remove the cylinder head in accordance with section 3.5 B.
2. Remove cylinder in accordance with section 3.6 B.
3. Remove the clutch assembly in accordance with section 3.8 B.
4. Remove the gear shift fork in accordance with section 3.10 B.
5. Separate the right and left crankcase in accordance with section 3.11B, the transmission components will be exposed.
6. Pull out the kick starter spindle, ① (Fig. 3.96)
7. Remove the main shaft ①, counter shaft ② and the gear shift drum ③ from the left crankcase as individual assemblies. (Fig. 3.97)
8. Remove the gear shift guide pin clip ① and pull out the gear shift fork guide pin; the gear shift fork ② can be disassembled from the gear shift drum. (Fig. 3.98)



### C. Inspection

#### 1. Main shaft to main shaft gear clearance (Fig. 3. 99)

Item	Standard value	Serviceable limit
Second gear ①	0.016~0.052 mm (0.0006~0.0020 in)	Replace if over 0.1 mm (0.004 in)
Top gear ②	0.016~0.052 mm (0.0006~0.0020 in)	Replace if over 0.1 mm (0.004 in)

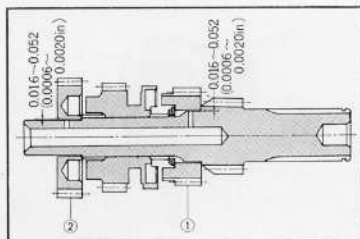

Fig. 3. 99 Main shaft to gear clearance  
① Main shaft second gear  
② Main shaft top gear

#### 2. Counter shaft to counter shaft gear clearance (Fig. 3. 100)

Item	Standard value	Serviceable limit
Low gear ①	0.016~0.052 mm (0.0006~0.0020 in)	Replace if over 0.1 mm (0.004 in)
Third gear ②	0.016~0.052 mm (0.0006~0.0020 in)	Replace if over 0.1 mm (0.004 in)

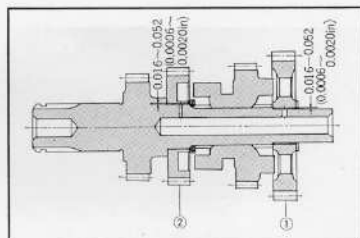

Fig. 3. 100 Counter shaft to gear clearance  
① Counter shaft low gear  
② Counter shaft third gear

#### 3. Transmission gear backlash

Standard value: 0.084~0.170

0.0034~0.0068 in

Serviceable limit: Replace if over 0.2 mm (0.008 in)

#### 4. Shaft to bearing clearance

Item	Standard value	Serviceable limit
Main shaft to left crankcase	0.016~0.052 mm (0.0006~0.0020 in)	Replace if over 0.13 mm (0.0052 in)
Counter shaft to right crankcase	0.016~0.052 mm (0.0006~0.0020 in)	Replace if over 0.13 mm (0.0052 in)

#### 5. Shift fork to shift drum clearance

Standard value: 0.025~0.075 mm

(0.0010~0.0030 in)

Serviceable limit: 0.15 mm (0.0060 in), replace

#### 6. Bend in shift fork

Standard value: 0.05 mm (0.0020 in)

Serviceable limit: 0.2 mm (0.008 in), replace

#### 7. Shift drum groove (Fig. 3. 101)

Standard value: 6.1~6.2 mm

(0.2401~0.2441 in)

Serviceable limit: Replace if over 6.4 mm (0.256 in)

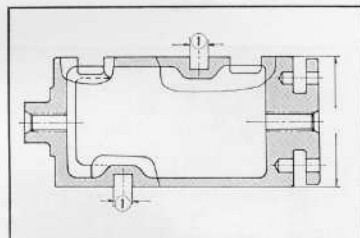

Fig. 3. 101 Shift drum groove  
① Shift drum groove

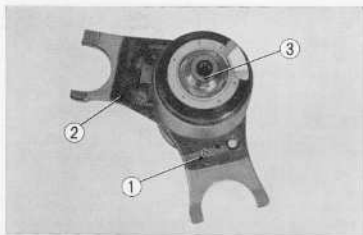

Fig. 3.102 "R" mark on the RH gear shift fork  
 ① "R" mark  
 ② Gear shift fork  
 ③ Gear shift drum

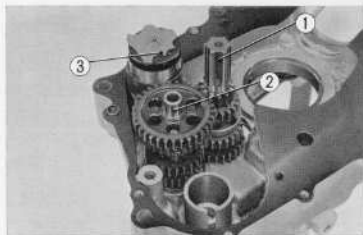

Fig. 3.103 Reassembling the transmission  
 ① Transmission main shaft  
 ② Transmission counter shaft  
 ③ Gear shift drum

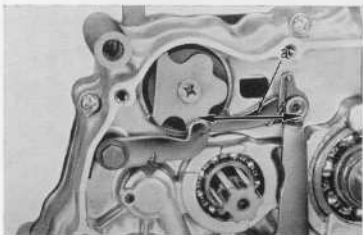

Fig. 3.104 Checking the gear shift arm

#### D. Reassembly

1. Install the gear shift forks ② on the gear shift drum ③. Insert the gear shift guide pins and fix in place by setting the clip.

#### CAUTION:

When assembling the gear shift forks, caution not to reverse the LH and the RH forks. The RH gear shift fork is marked "R" ①. After the assembly, check for operation. (Fig. 3.102)

2. In the assembly of the transmission gears, those gears which are fixed to rotate with the shaft shall be fitted to the splines with care and those which are free rotating must be installed with the thrust washers. After the assembly, check for proper operation.
3. Install the transmission main shaft, counter shaft, gear shift drum assembly on the left crankcase. (Fig. 3.103)
4. Install the kick starter spindle.
5. Assemble the LH and RH crankcases in accordance with section 3.11D.
6. Install the gear shift spindle and the driven gear in accordance with section 3.10D and the clutch assembly the RH crankcase cover in accordance with section 3.8D.
7. Install the cylinder in accordance with section 3.5D and the cylinder head in accordance with section 3.6D.
8. Install the gear shift spindle in the reverse order of section 3.12B.

#### CAUTION:

When assembling, check for area "a" operation and also check the shift return spring pin for bend. (Fig. 3.104)

9. Install the shift drum stopper and the driven gear.
10. Install the oil pump. Install the clutch assembly in accordance with section 3.8D. Install the lock washer, lock nut and lock the nut by bending the washer tab.

Install the clutch outer cover and the right crankcase cover.

### 3.13 CRANKCASE

#### A. Construction

The crankcase is an integral part of the transmission made in the right and left halves from aluminum alloy die casting. (Fig. 3.105)

The cylinder is mounted at the forward end and held in place by the cylinder head stud bolts screwed into the crankcase.

A breather compartment and a breather passage are incorporated in the upper section of both crankcase halves to dissipate the pressure built-up in the crankcase.

A cam chain tensioner is incorporated into the left crankcase half. In the forward lower section of the right crankcase is included an oil strainer and which together with the centrifugal filter purifies the lubrication oil which is pressure fed to the various components of the engine.

#### (BREATHERS)

The interior of the crankcase is continually under varying pressures, built up by the reciprocating piston, in addition, the crankcase is filled with the gases from the blow-by of the piston and the gases

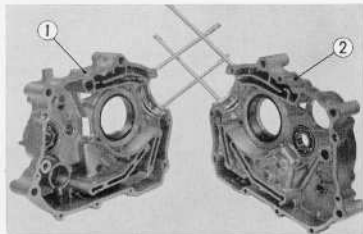

Fig. 3.105 Crankcases  
① Left crankcase  
② Right crankcase

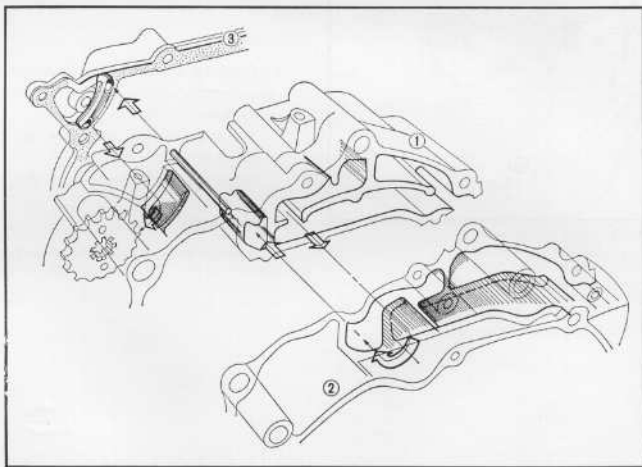

Fig. 3.106 Crankcase  
① L. crankcase    ② R. crankcase    ③ L. crankcase cover

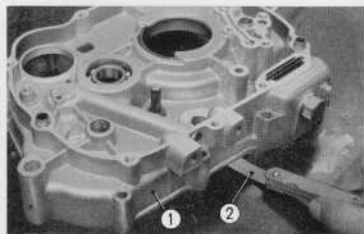

Fig. 3.107 Measuring the crankcase flatness with a thickness gauge

- ① Crankcase
- ② Thickness gauge

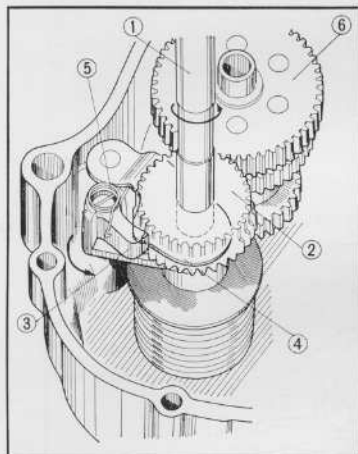

Fig. 3.108 Kick starter mechanism

- ① Kick starter spindle
- ② Kick starter pinion
- ③ Kick starter ratchet flange
- ④ Kick starter guide
- ⑤ Kick starter pawl spring
- ⑥ Counter shaft low gear

produced by the heat of the crankcase. For this reason, the decompression of the oil leaks at the case parting area is increased.

The breather is designed and incorporated in the case to exhaust the gases to the outside and also to maintain a constant pressure within the crankcase. (Fig. 3.106)

#### B. Disassembly

1. Remove cylinder head, refer to section 3.5 B
2. Remove cylinder, refer to section 3.6 B.
3. Remove clutch assembly as a unit, refer to section 3.8 B.
4. Remove gear shift spindle, refer to section 3.10 B.
5. Separate the right crankcase from the left, refer to section 3.11 B.
6. Remove the main shaft and counter shaft, refer to section 3.12 B.

The gear shift fork assembly and the kick starter can be removed. The crankshaft can be removed as a unit for disassembly.

7. The right crankcase will have the oil strainer and the left crankcase will have the cam chain tensioner and ignition coil mounted. The oil filter screen can be removed from the right crankcase.

#### C. Inspection

1. Check for damages especially around the machined mating surfaces since even a small defect will cause oil leaks.

The mating surfaces should be flat to within 0.05 mm (0.002 in)

Measure with a thickness gauge. (Fig. 3.107)

#### D. Reassembly

1. Assemble in the reverse order of section 3.13 B.

### 3.14 KICK STARTER AND GEAR INTERLOCK MECHANISM

In this system, where the kick starter pinion (2) is engaged to the low gear (6), the kick or starting is light and easy, and the use of the transmission gear reduces the possibility of trouble.

As shown in Fig. 3.108, when the kick starter spindle (1) is rotated by a kick, the kick starter ratchet flange (3), is rotated simultaneously.

The shaft of the kick starter ratchet flange slides down from the kick starter ratchet guide (4) and is pressed to the teeth of the kick starter pinion by the shaft spring (5). Power is transmitted to the countershaft low gear (6) from the kick starter pinion. (2)

When the kick starter spindle returns after kicking as shown in Fig. 3.109 the kick starter ratchet flange is pressed back by the kickstarter spring. The shaft rides on the kick starter ratchet guide and the kick starter pinion is freed.

Fig. 3.110 shows the gear interlock from the

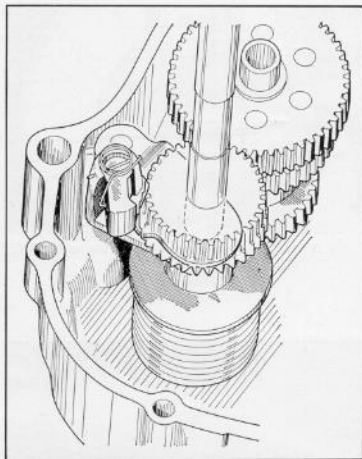

Fig. 3.109 Kick starter mechanism

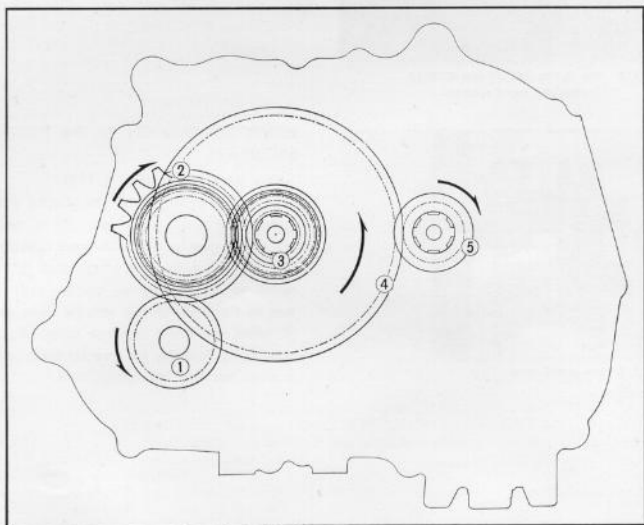

Fig. 3.110 Gear interlock mechanism

- |                       |                          |              |
|-----------------------|--------------------------|--------------|
| ① Kick starter pinion | ② Counter shaft low gear | ③ Main shaft |
| ④ Primary driven gear | ⑤ Primary drive gear     |              |

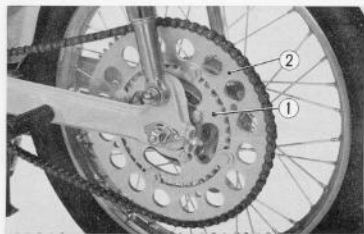

Fig. 3.111 Earlier series rear sprocket (Prior to CT 90 F, No. 122550)

- ① Final driven sprocket A
- ② Final driven sprocket B

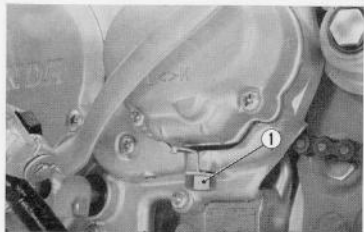

Fig. 3.112 From F, No. 122551 and 000001A

- ① High/Low speed selector

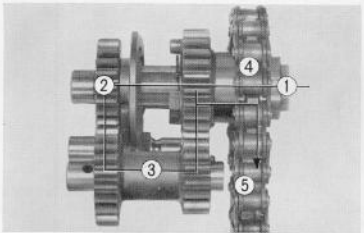

Fig. 3.113 Low speed range

crankshaft, from which the rotation direction and positions of shafts may be seen.

### 3.15 POSI-TORQUE MECHANISM (CT 90)

#### A. Construction

The CT90 models (from frame No. 122551 and 000001A) are equipped with a posi-torque to select between the high and low speed range, in lieu of replacing the sprocket as in the earlier series, to provide greater driving power in the final drive at a reduced speed.

The incorporation of the posi-torque requires only the operation of the high/low speed range selector to change the driving speed, a great time saving over the earlier series which required the remounting of the large sprocket and changing the length of the chain. (Fig. 3.111, 3.112)

#### POWER TRANSMISSION IN THE POSI-TORQUE MECHANISM

##### • Low speed range. (Fig. 3.113)

In the low speed range, the selector slides the splined posi-torque high gear ② to mesh with the driven gear of the posi-torque counter shaft ③. The power from the counter shaft ① is transmitted to the posi-torque counter shaft ③ and then to the free rotating sprocket drive gear unit ④ where the speed reduction takes place. The chain ⑤ is driven by the sprocket which rotates at a speed less than the counter shaft.

• High speed range (Fig. 3.114)

In the high speed range, the selector slides the splined posi-torque high gear ③ to lock with the free rotating sprocket drive gear unit ④. The power from the counter shaft ① is transmitted from the posi-torque high gear directly to the free rotating sprocket drive gear unit ④ to drive the sprocket at the same speed as the counter shaft.

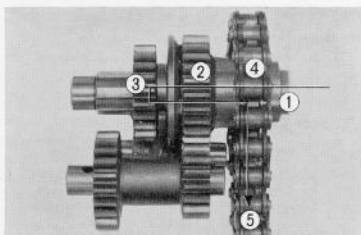

Fig. 3.114 High speed range

**B. Disassembly**

1. Remove the four, 6 mm screws and take off the posi-torque cover.
2. Remove the posi-torque low gear and the counter gear assembly together with the counter shaft.
3. To disassemble the posi-torque high gear, remove the 20 mm circlip and the splined washer.
4. The left crankcase cover must be removed and the chain unhooked from the sprocket to disassemble the drive sprocket.

### 3.16 CARBURETOR

**A. Construction**

(1)

The air taken in from the air cleaner enters the inlet side (1) of the carburetor as a main air flow, passes under the throttle valve (6) and then leave the carburetor through passage (8) to be taken into the engine. This flow of air creates a negative pressure around the needle jet (4) and causes the fuel in the float chamber (2) to be drawn up through the main jet (10), the needle jet holder (3) where it is mixed with the air that is taken in at air jet (5) and enters through the air bleed holes (9) located around the needle jet holder (3), and is then discharged between the needle jet (4) and jet needle (7) located directly below the throttle valve (6). The discharged fuel is mixed with the main air flow and atomized before being taken into the engine.

In addition, to regulate the fuel mixture at small throttle opening, the air taken in from carburetor inlet (1) passes by the opening (12) of the air screw (11), enters the slow jet (13) by the way of the bleed hole, and then is mixed with the fuel discharged from the hole located under the throttle valve to produce a rich fuel mixture. This discharged fuel mixture is mixed with the main inlet air flow and taken into the engine. The fuel mixture adjust-



Fig. 3.115 Carburetor

ment of the slow system is made by regulating the air screw (11).

Turning the air screw clockwise will produce a rich mixture. Turning the air screw counter clockwise will produce a lean mixture.

#### (2) Float Chamber

The carburetor produces fuel mixture which is

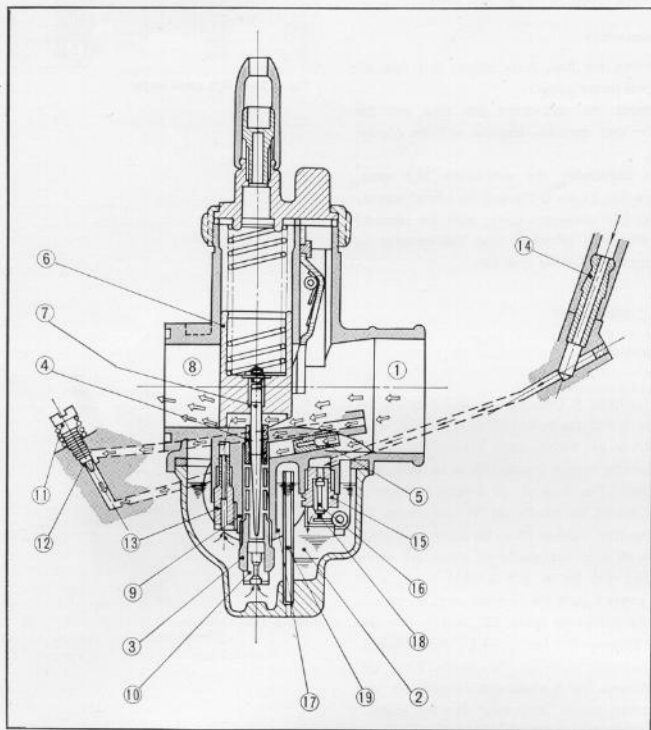

Fig. 3.116 Cross-sectional view of carburetor

- |                             |                            |
|-----------------------------|----------------------------|
| ① Inlet side of carburetor  | ⑪ Air screw                |
| ② Float chamber             | ⑫ Opening of the air screw |
| ③ Needle jet holder         | ⑬ Slow jet                 |
| ④ Needle jet                | ⑭ Fuel passage             |
| ⑤ Air jet                   | ⑮ Valve seat               |
| ⑥ Throttle valve            | ⑯ Float valve              |
| ⑦ Jet needle                | ⑰ Float                    |
| ⑧ Outlet side of carburetor | ⑱ Float arm                |
| ⑨ Air bleed holes           | ⑲ Over flow pipe           |
| ⑩ Main jet                  |                            |



suited to the throttle opening and engine speed. However, for that purpose, it is necessary to keep fuel level constant in the carburetor. This is performed by the float chamber. The fuel from the fuel tank passes through the passage (14), between valve seat (15) and the valve (16), and then enters the float chamber (2). The float (17) becomes buoyant as fuel enters, raises the float valve (16) hinged at the float arm and which seats the float valve into the valve seat to stop the flow of the fuel. When fuel in the float chamber is consumed and the fuel level drops, the float (17), lower along with the fuel level. Clearance between the valve (16) and the valve seat (15), allows fuel to enter the float chamber. By repeating this, the level is always maintained constant. A spring is fitted into the section of the valve (16) which contacts the float arm (18), and prevents the valve from oscillating.

When the vehicle is on a grade or when dirt is lodged between the valve and seat, gasoline will over flow and enters the cylinder. Therefore, for preventing the fuel from rising above a certain level, an overflow line is installed. (Fig. 3.116)

### (3) Choke

When an engine is cold or the temperature is low during starting, a rich fuel mixture is temporarily required. This can be had by the use of the choke. When the choke lever is pulled up, the choke (20) is fully closed. The opening (23) is normally closed by the relief valve (21), however, during starting when the throttle is opened approximately 1/4 and the kick starter operated, the negative pressure created in the cylinder will cause the relief valve (21) to open by the proper amount (dotted section 24) and permit air to pass through the carburetor; this flow of air draws the fuel out of the needle jet (4) to provide an air fuel mixture ideal for starting. After the engine starts, the inlet negative pressure increases, and causes the relief valve (21) to open correspondingly wider to assure a suitable mixture. Thus, the opening of the relief valve (21) changes according to the opening of the throttle valve (6), section (25). (Fig. 3.117)

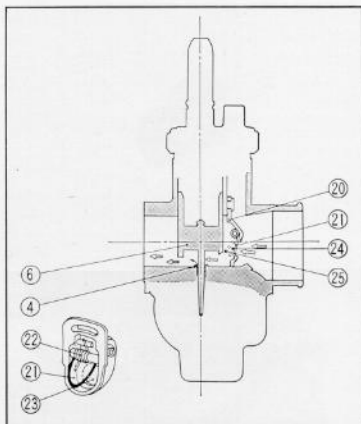

Fig. 3.117 Choke

## B. Functions of Each Component

### (1) Main Jet

Its main purpose is to obtain a proper fuel mixture ratio by controlling the flow of fuel when the throttle



Fig. 3.118 Main jet

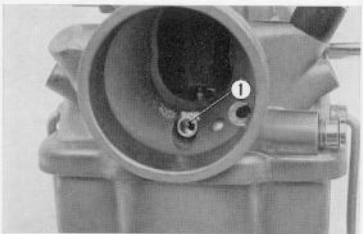

Fig. 3.119 ① Air jet



Fig. 3.120 Needle jet

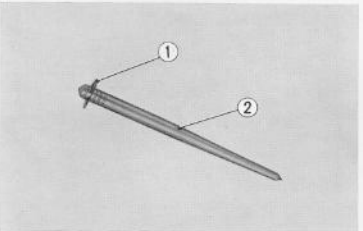

Fig. 3.121 Jet needle  
 ① Needle clip  
 ② Jet needle

is fully opened (operating at the maximum speed). However, the fuel ratio is influenced down to around one half throttle opening. (Fig. 3.118)

#### (2) Air Jet

To prevent the mixed gas from becoming rich at high speed, and lean at low speed, air is feed to the needle jet holder. The function of the air jet is to controls the amount of air. At a constant throttle opening, the larger the air jet, the smaller will be the difference in fuel flow between high and low speeds, and a consequent reduction in fuel flow. (Fig. 3.119)

#### (3) Needle Jet

The needle jet controls the fuel which had been metered by the main jet, between the intermediate and full throttle. The control is performed by varying the clearance between the needle jet and jet needle described in the following section. Hole in the needle jet is made with high degree of precision to assure accurate fuel control. (Fig. 3.120)

#### (4) Jet needle

The jet needle, in conjunction with the above mentioned needle jet, controls the fuel mixture ratio at intermediate throttle opening (mainly between 1/4 to 1/2). The long tapered jet needle is fitted in the center hole of the throttle valve with the tapered end inserted into the needle jet. The vertical movement of the throttle valve correspondingly moves the tapered jet needle within the needle jet, varying the clearance between the needle and the jet, and in this way, the proper fuel mixture is obtained in reference to the position of the throttle valve. There are five clip groove positions on the head of the jet needle. The fuel mixture becomes richer as the clip is moved from the first groove (top) toward the fifth groove. (Fig. 3.121)

#### (5) Throttle valve

The throttle valve regulates the amount of air taken into the engine, this essentially controls the engine speed as well as the power output, in addition, the throttle valve performs other important control functions.

The skirt of the throttle valve is cut at an angle on the inlet side; the size of this cutaway is designated by the cutaway number which is described in succeeding section F.2. By changing the valve with a different size cutaway, the negative pressure in the vicinity of the needle jet is changed, affecting the fuel flow and consequently changing the fuel

mixture ratio. This change is effective in the slow speed range between idling and 1/4 throttle opening and has no effect above 1/2 throttle opening. (Fig. 3. 122)

(6) Slow jet

The slow jet meters the flow of the fuel at idling and in the slow speed range, and causes the fuel to be atomized by mixing it with the air taken in from the air bleed holes. (Fig. 3. 123)

(7) Air screw

The air screw regulates the amount of air entering the slow speed system. The air which passes by the air screw mixes with the fuel from the slow jet and is discharged in the proper mixture, producing a spray to assist vaporization. (Fig. 3. 124)

### C. Adjustment

In order for the carburetor to produce the maximum performance of the engine's capability it must be adjusted so that a proper fuel mixture is available over the complete speed range from idling to the maximum speed, and further, be able to maintain this condition. This carburetor has been designed and manufactured to satisfy these conditions by the precision manufacture of the components and specially in the use of superior quality wear resistant materials. The jet needle, needle jet, throttle valve and the float valve being susceptible to wear, has been made of materials possessing good wearing characteristics, precisely manufactured and surface treated to give extended satisfactory service without change to performance.

The adjustments are accurately made and performance checked by both the manufacturer and factory personnel to assure that the setting of the various parts are precise. Therefore, when making any adjustments, performing engine repair or replacing worn parts, give particular attention to the following points.

- ① Make sure that the engine is adjusted in accordance with the specifications.
- ② Check to see that there are no air leaks at the carburetor mounting flange.
- ③ When the controlling components become worn, replace with new parts.



Fig. 3. 122 Throttle valve



Fig. 3. 123 Slow jet

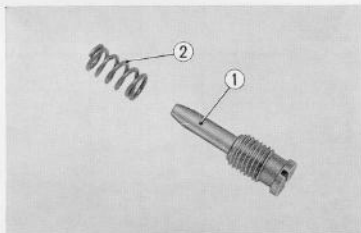

Fig. 3. 124 Air screw  
① Air screw  
② Air screw stop spring

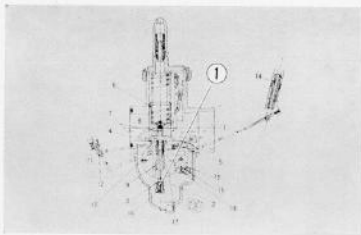

Fig. 3.125 Main jet  
① Main jet

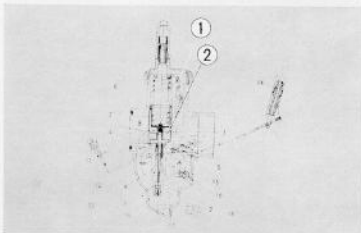

Fig. 3.126 Jet needle, Throttle valve  
① Jet needle  
② Throttle valve

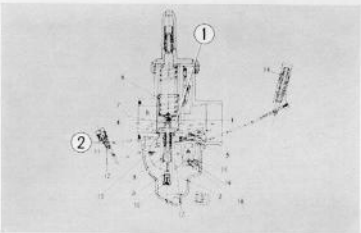

Fig. 3.127 Throttle valve, Air screw  
① Throttle valve  
② Air screw

#### D. Adjustment for High Speed

The control of the fuel mixture between 1/2 throttle to full throttle opening is the function of the main jet. (Fig. 3.125)

The determination of the fuel mixture ratio is made by the following method.

- (1) At full throttle, if the engine speed increases when the choke is slightly closed, it is an indication of lean mixture. Progressively replace the main jet and note the performance. (Main jets are numbered in sequence of 5.)
- (2) If the engine speed drops when the choke is slightly closed, it indicates that the main jet is either of the proper size or that it may be too large, in which case, perform the following check to make the determination.
  - (a) If the main jet had been of a proper size, the engine speed will drop when the main jet is replaced with one of a smaller size; the speed will increase if the choke is slightly closed. In such case, the original jet was of the proper size and therefore should be reinstalled.
  - (b) If the main jet had been too large, replace the main jet in sequence with that of a smaller size until the condition in (a) above is found and then reinstall the proper size jet.

#### E. Adjustment for Intermediate Speed

The fuel mixture adjustment in the intermediate speed range between 1/8 to 1/2 throttle opening is made by relocating the jet needle positioning clip and replacing the throttle valve with that of a different size cutaway. However, changing the throttle valve will also effect the operating condition below the speed range of 1/8 throttle opening, therefore, it is very difficult to adjust for intermediate speed by replacement of the throttle valve only. It is recommended that the adjustment for the intermediate speed be made by the jet needle, and stay within the range of acceptable accelerating performance since this would give a fuel consumption that is much lower. (Fig. 3.126)

- (1) Jet needle
  - (a) Black smoke emitted from the exhaust gas at intermediate speed is an indication of too rich a fuel mixture and is corrected by

- adjusting the jet needle to a lower position
- (b) Flat spot (similar to engine missing) during acceleration or at intermediate speed indicates that the fuel mixture is too lean and is corrected by adjusting the jet needle to a higher position.
- (2) Throttle valve (cutaway)
- The throttle valve is numbered so that the larger the stamped number size, leaner the fuel mixture will be. When changing the throttle valve, it must be considered that slow speed will be affected as well as the intermediate speed.

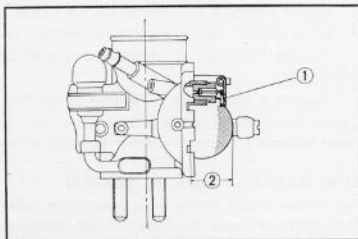

Fig. 3.128 Measurement of fuel in the float chamber

- ① Float arm  
② Float fuel standard surface

#### F. Adjustment for Slow Speed

The adjustment of the fuel mixture between 1/8 throttle opening and idling is made by the air screw and the cutaway of throttle valve. (Fig. 3.127)

##### (1) Air screw

The fuel mixture adjustment at idling speed is made by the air screw. Turning the screw in the clockwise direction will produce a rich mixture; a lean mixture can be had by turning the screw in the counter clockwise direction. However, the idle screw is not only to adjust the idling since attention should also be given to the transition period from idling to throttle opening, in other words, the fuel mixture to provide the smooth operation at the point where throttle is opened slightly beyond the idle speed.

#### G. Adjusting the Fuel Level

Since it is difficult to measure the actual height of the fuel level, the measurement of the height of the float valve is made which, will correspond to the height of the fuel.

Float measuring method

- (a) Tap the float lightly from left to right with the finger and locate the position where the tip of the float valve just barely comes in

contact with or a clearance of 0.1 mm (0.004 in) exist between the float arm.

- (b) In this position, the distance between the base of the float and the carburetor body (2) should measure 21.0 mm (0.827 in). If adjustment is required, carefully bend the float arm by the proper amount.

**CAUTION:**

A spring is incorporated in the base of the float valve, therefore if the float arm is pressed against the valve, the spring will recede into the valve and true indication will not be obtained. Careful observation must be made to accurately detect the point of contact between the float arm and the float valve.

**(CT 90 Model From Frame No. 000001A)**

An altitude selector knob is incorporated in the carburetor of the CT 90 model starting with frame serial No. CT 90-000001A/engine serial No. CT 90E-000001A. This makes available optimum carburetor performance for normal or high altitude motorcycle operation.

Pull the knob out for riding at altitude of 6,000 feet above sea level. This will provide additional supply of air to the needle jet from the main air supply passage. At the same time, additional is also supplied to slow jet from the slow system air passage, to lean out the fuel mixture.

Pushing in the knob will close off the air supply to both the slow and main systems.

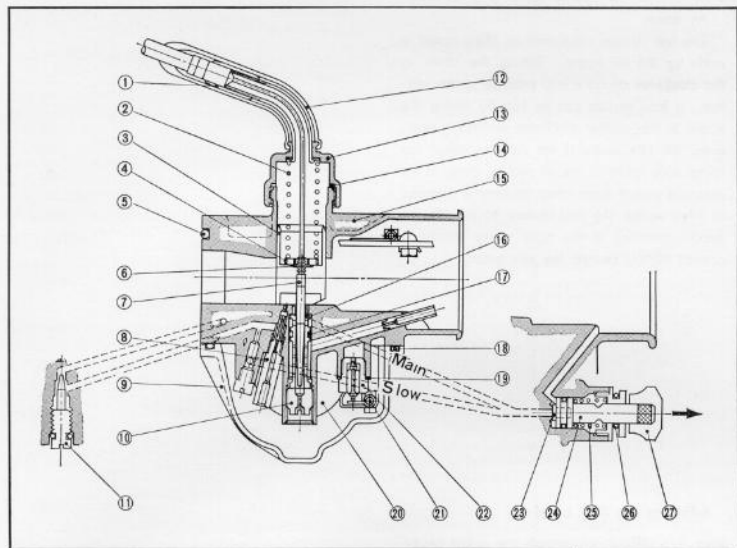

- ① Throttle cable adjuster
- ② Throttle spring
- ③ Throttle valve
- ④ Needle clip plate
- ⑤ O ring
- ⑥ Bar clip
- ⑦ Jet needles
- ⑧ Slow jet
- ⑨ Float chamber body

- ⑩ Main jet
- ⑪ Air screw
- ⑫ Rubber cap
- ⑬ Top
- ⑭ Top washer
- ⑮ Body
- ⑯ Needle jet
- ⑰ O ring
- ⑱ O ring

- ⑲ Washer
- ⑳ Float
- ㉑ Float arm pin
- ㉒ Float valve
- ㉓ Rubber cap
- ㉔ Check valve
- ㉕ Coil spring
- ㉖ Special clip
- ㉗ Knob

CARBURETOR SETTING TABLE

Model	S 90		CL 90, CL 90 L		CD 90		C 90		CT 90		CT 90 (from F. No. 000001A)	
	1000—133—00		1000—152—00		1000—131—00		1000—109—00		1000—108—00			
Main jet	# 85		# 85		# 90		# 75		# 72		# 80	
Air jet	# 150		# 150		# 150		# 120		# 120		# 120	
Air bleed	1 0.7×4 5 2 0.6×2 6 3 0.6×2 7 4 0.6×2 8	0.6×2 0.7×2 0.7×2 0.7×2	1 0.7×2 5 2 0.7×2 6 3 0.7×2 7 4 0.7×2 8	0.7×4 0.7×2 0.7×2 0.7×2	1 0.7×2 5 2 0.7×2 6 3 0.7×2 7 4 0.7×2 8	0.7×2 0.7×2 0.7×2 0.7×2	1 0.5×2 5 2 6 3 0.4×2 7 4 0.4×2 8	0.4×2 6 7 8	1 0.4×2 5 2 0.4×2 6 3 0.4×2 7 4 0.4×2 8	0.4×2 6 7 8	0 1.3×2 4 1 0.6×4 5 2 0.8×2 6 3 — 7	2.60×3.4
Needle jet	2.60×3.7		2.60×3.7		2.60×3.5		2.60×3.7		2.60×3.5		2.60×3.4	
Jet needle	16241—2 stage		16241—2 stage		163011—3 stage		16332—2 stage		16332—3 stage		3 stage	
Choke valve (Throttle valve)	# 2.5 Width: 1.2 Depth: 0.3 Clear provided		# 2.5 Width: 1.2 Depth: 0.3 Clear provided		# 2.5 Clear not provided		# 2.0 Width: 1.2 Depth: 0.3 Clear provided		# 2.0 Width: 1.4 Depth: 0.3		# 2.5 Width: 1.2 Depth: 0.2	
Air screw	1.1/8±1/8	1.3/8±1/8	1.1/8±1/8	1.3/8±1/8	1.1/8±1/8	1.1/8±1/8	1.0±1/8	1.0±1/8	1.1/8±1/8	1.1/8±1/8	1.1/8±1/8	
Slow jet	# 38 AB <sub>1</sub> AB <sub>2</sub> AB <sub>3</sub> AB <sub>4</sub>	0.9×2 0.9×2 0.9×2 0.9×2	# 40 AB <sub>1</sub> AB <sub>2</sub> AB <sub>3</sub> AB <sub>4</sub>	0.9×2 0.9×2 0.9×2 0.9×2	# 40 AB <sub>1</sub> AB <sub>2</sub> AB <sub>3</sub> AB <sub>4</sub>	0.9×2 0.9×2 0.9×2 0.9×2	AB <sub>1</sub> AB <sub>2</sub> AB <sub>3</sub> AB <sub>4</sub>	0.8×2 0.8×2 0.8×2 0.8×2	AB <sub>1</sub> AB <sub>2</sub> AB <sub>3</sub> AB <sub>4</sub>	0.9×2 0.9×2 0.9×2 0.9×2	AB <sub>1</sub> AB <sub>2</sub> AB <sub>3</sub> AB <sub>4</sub>	0.8×2 0.8×2 0.8×2 —
Valve seat	1.5		1.5		1.5		1.2		1.2		1.5	
B. F.	1 2	1 1.0 2	1 2	1 2	1 2	1 2	1 2	1 2	1 2	1 2		
Pillar outlet	1 1.0 pitch 7.0	1 pitch 7.0	1 1.1 pitch 6.3	1 1.2 pitch 5.1	1 1.2 pitch 5.1	1 1.2 pitch 5.1	1 1.2 pitch 5.1	1 1.0 pitch 5.1	1 1.0 pitch 5.1	1 0.9	Pitch 5.5	
P. A. J.					# 60							
P. W. J.												
P. W. A. J.												
Fuel level	16.5		19.5		19.5		19.5		19.5		27 (adjustment height 23.5)	
Setting Mark	5 90 C		1 90 A		B		D		B		T 90 KA	

Setting Specification

## 4. FRAME

Tools Necessary for Disassembly and Reassembly

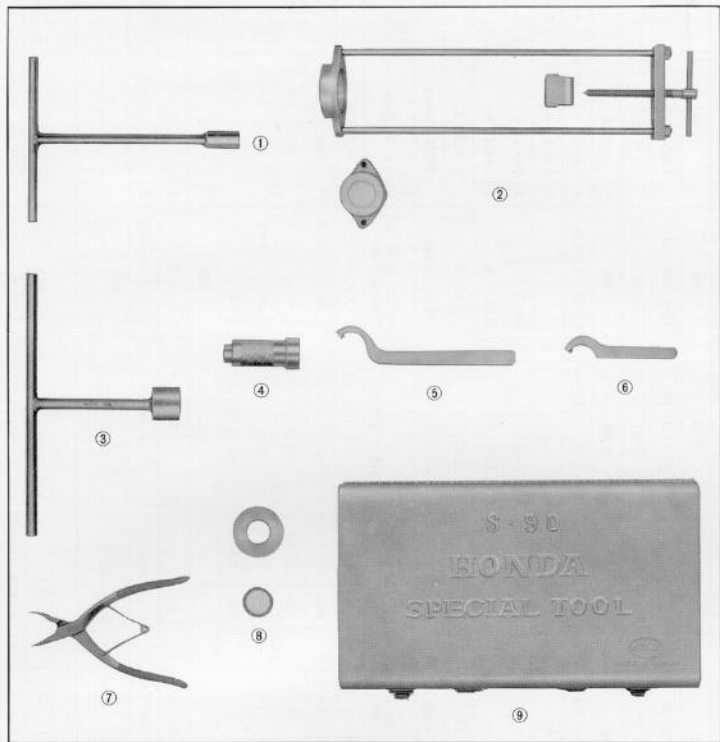

TOOL No.	DESCRIPTION
① 07045-03301	Return pin socket wrench
② 07035-03301	Rear cushion disassembling & assembling tool
③ 07083-03001	Stem nut socket wrench
④ 07048-03001	Bearing driver
⑤ 07072-00101	Pin Spanner, 36 mm
⑥ 07071-25001	Main switch pin spanner
⑦ 07782-99925	Snap ring pliers (close)
⑧ 07054-02801	Front fork oil seal driver
⑨ 07790-02801	Tool case



## 4.1 STEERING HANDLE

### A. Construction

The steering handles of all the model 90 motorcycles with the exception of C 90 are made of formed steel pipe.

They are mounted to the front fork by being clamped between the upper and lower handle pipe holders and bolted to the fork top bridge plate. The steering handle of the C 90 is made of pressed sheet steel with a continuous steel pipe grip welded for reinforcement.

Model	Type handle
S 90 (Fig. 4.1-11)	Semi-up
CL 90, CL 90 L (Fig. 4.1-2)	Up-handle
CD 90 (Fig. 4.1-3)	Semi-up
C 90 (Fig. 4.1-4)	Pressed sheet steel
CT 90 (Fig. 4.1-5)	Up-handle

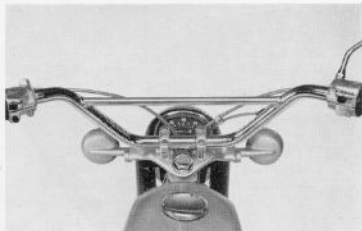

Fig. 4.1.2 CL 90, CL 90 L steering handle



Fig. 4.1.3 CD 90 steering handle

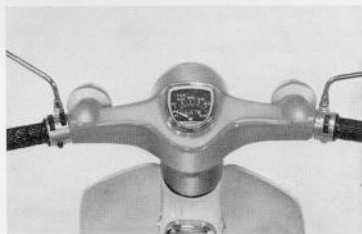

Fig. 4.1.4 C 90 steering handle

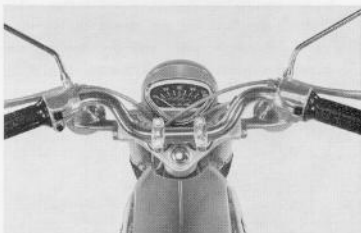

Fig. 4.1.1 S 90 steering handle

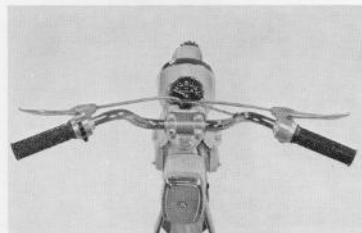

Fig. 4.1.5 CT 90 steering handle

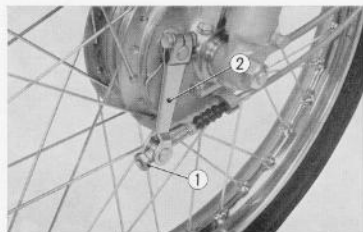

Fig. 4.2 Removing brake adjusting nut  
① Brake adjusting nut ② Brake arm

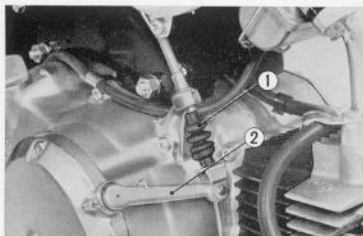

Fig. 4.3 Disconnecting the clutch cable  
① Clutch cable ② Clutch lever

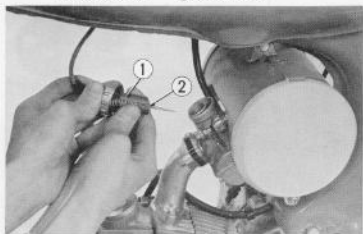

Fig. 4.4 Removing throttle cable from carburetor  
① Throttle valve ② Cable end

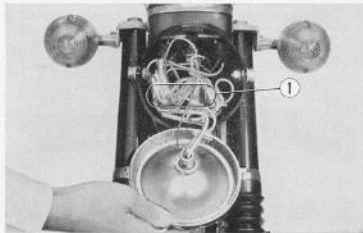

Fig. 4.5 Disconnecting electrical leads  
① Electrical leads

## B. Disassembly

(S 90, CL 90, CL 90 L)

1. Hold the front brake arm ② back and unscrew the adjusting nut. ① (Fig. 4.2)

2. Disconnect the clutch cable ① lower end from the clutch lever ②. (Fig. 4.3)

### CAUTION:

- a. Exercise care not to damage the cylinder and cylinder head fins when removing the cable.
- b. The task can be simplified by loosening the adjusting screw at the handle lever end and disconnecting the cable.

3. Disconnect the throttle cable at the throttle valve ① by unscrewing the carburetor cap, pulling out the throttle valve and then unhooking the throttle cable ②. (Fig. 4.4)

4. Remove the horn, turn signal and dimmer switch lead ① by loosening the screws at the front of the headlight case, and disconnecting the connectors within the headlight case. (Fig. 4.5)

5. Remove the four hex bolts mounting the handle pipe between the upper and lower holders and remove the steering handle ① together with the control cables. (Fig. 4.6)

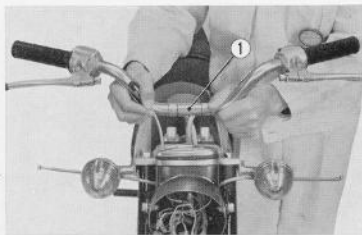

Fig. 4.6 Removing handle pipe ① Handle pipe

6. The fork top bridge ④ is removed together with the turn signal lights by removing the front fork bolts ③ and the steering stem nut ②. (Fig. 4.7)

Use stem nut socket wrench ① (Tool No. 07083-03001) to loosen the stem nut.

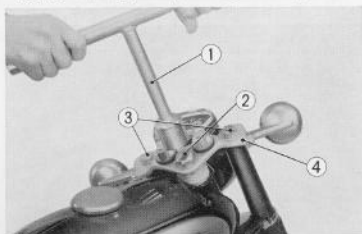

Fig. 4.7 Removing the top bridge plate  
① Stem nut socket wrench ② Stem nut  
③ Front fork bolt ④ Fork top bridge

7. In order to remove the clutch and brake cables from the handle lever, loosen the cable adjusting bolts ②, align the lock nut ① to the groove and separate from the handle lever. Remove the cable end from the lever. (Fig. 4.8)

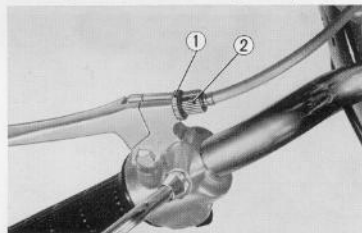

Fig. 4.8 Removing brake and clutch cables  
① Lock nut ② Cable adjuster

8. Remove the two 5 mm screws to separate the right handle grip bracket, turn signal switch assembly, throttle grip pipe and then disconnect the throttle cable ① from the throttle cable hinge ②. (Fig. 4.9)

9. Remove the hex stem nut to disassemble the handle pipe lower holder, handle cushion upper and lower rubbers and handle cushion seat from the top bridge plate.

**NOTE:**

When removing the handle pipe lower holder from the top bridge, loosen the 10 mm hex nut before removing the handle. This will prevent the holder and nut from turning and facilitates removal.

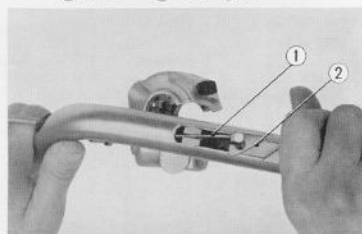

Fig. 4.9 Removing throttle cable  
① Throttle cable ② Throttle cable hinge

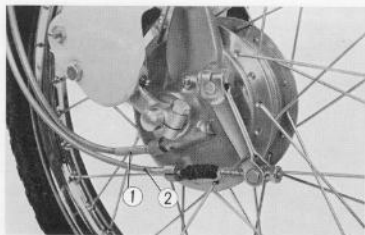

Fig. 4.10 Disconnect speed and brake cable  
① Speedometer cable ② Brake cable

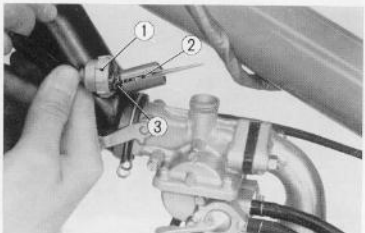

Fig. 4.11 Removing throttle cable from carburetor  
① Carburetor cap ② Throttle valve ③ Throttle cable

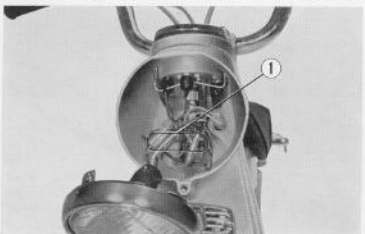

Fig. 4.12 Disconnect electrical leads (CT 90)  
① Electrical leads

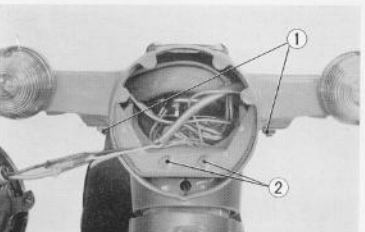

Fig. 4.13 Removing handle setting bolts  
① 8 mm hex nut ② 6 mm hex bolt

#### (C 90, CT 90)

1. Remove the front cover. (C 90)
2. Uncouple the speedometer cable ① and disconnect the front brake cable ②. (Fig. 4.10)  
The left handle lever of the CT 90 is the brake lever for the rear brake.  
Remove the cable end from the handle lever. Loosening the adjuster nut at the rear wheel will simplify the task.
3. Disconnect the throttle cable at the throttle valve by first unscrewing the carburetor cap ①, pulling out the throttle valve ② and then unhooking the throttle cable. ③ (Fig. 4.11)
4. Remove the headlight mounting screw and pull off the headlight unit. Disconnect the horn, turn signal and the dimmer switch leads ① at the connectors within the headlight case. (Fig. 4.12)
5. Unscrew the two top bridge setting bolts ② from within the headlight case and remove the two 8 mm handle setting nuts ①. (C 90) (Fig. 4.13) and lift off the handle together with the cables and leads.
6. Remove the four 6 mm hex bolts to separate the handle pipe upper holder. Then, pull out the steering handle ① together with the cables and electrical leads (Fig. 4.14) (CD 90 & CT 90)

#### (CT 90 Model from Frame No. 000001A)

1. Remove the front brake adjust nut and front brake cable from the front arm (front brake cable may be disconnected from the brake lever).
2. Remove the rear brake cable from the rear brake lever.
3. Remove the carburetor cap and disassemble the throttle valve together with the throttle cable from the carburetor.
4. Remove the headlight and disconnect the respective leads.
5. Unscrew the four handle mounting bolts and remove the handle bar.

#### C. Inspection (steering handle)

1. Inspect the throttle, clutch, front brake and rear brake (CT 90) cables for wear and damages, also check for smoothness of operation.
2. Check the handle levers for smooth operation.
3. Inspect the handle pipe for deformation and twist.
4. Check all the switches for proper operation and inspect the electrical leads for damages.

**D. Reassembly**

1. Assemble the handle pipe lower holder, handle cushion upper and lower rubber, turn signal lights and handle cushion seat to the top bridge plate.
2. Assemble the throttle and front brake cables, throttle grip and switch assembly to the steering handle.

**NOTE :**

- a. Apply grease on both the inside and outside of the pipe where the throttle grip is to be installed. This is to lubricate the movement of the throttle grip ② and its component parts. (Fig. 4.15)
  - b. Check the proper operation of all cables.
3. Assemble the fork top bridge plate on the front fork and install the front fork bolt and steering stem nut.
  4. Position the cables and electrical leads in their proper location and clamp the steering handle in its proper position between the upper and lower handle pipe holder with the four mounting bolts.

**NOTE :**

- a. Tighten the two forward bolts first, there should be a clearance of 0.2 to 0.3 mm (0.008~0.010 in) clearance between the holders at the rear before the rear bolts are tightened.
  - b. The serrations on the handle pipe should be located at the center of the holders.
  - c. Position the punch alignment mark on the handle pipe to the parting surface of the holders.
  - d. Torque the bolts to 80~110 kg.cm (5.8~8.0 ft.lb).
5. Connect all the electrical lead to the leads of the same color within the headlight case.
  6. Install and connect the throttle cable to the throttle valve and screw on the carburetor cap. Adjust the cable for proper amount of play.
  7. Connect the clutch cable to the clutch arm and adjust the play after installation to 10~20 mm (0.40~0.80 in) of free travel at the end of the clutch lever. (S 90, L 90, CL 90 L, CD 90)

**NOTE :** The adjustment of the clutch lever free travel can be made at both clutch cable upper adjuster ① (Fig. 4.16A) and at the clutch cable adjuster ① (Fig. 4.16B)

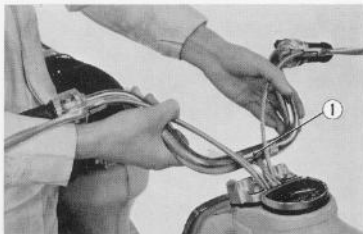

Fig. 4.14 Removing steering handle (CD 90 & CT 90)  
① Handle bar

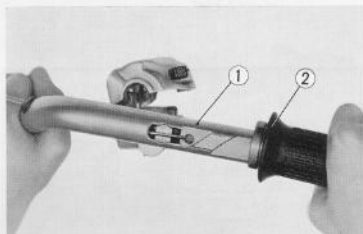

Fig. 4.15 Assembling throttle grip  
① Handle bar ② Throttle grip

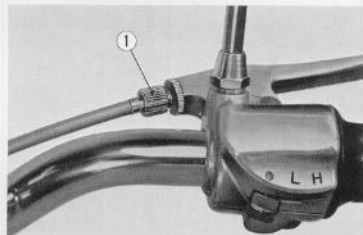

Fig. 4.16A ① Clutch cable upper adjuster

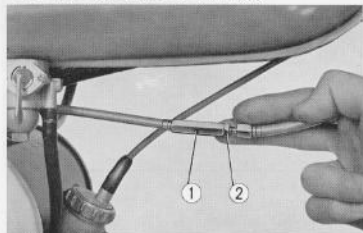

Fig. 4.16B ① Clutch cable adjuster ② Lock nu

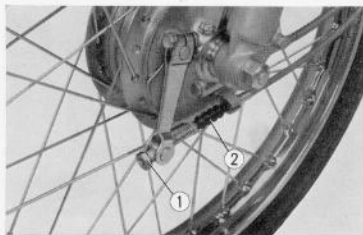

Fig. 4.17 Adjusting front brake  
 ① Front brake adjusting nut  
 ② Front brake cable

8. Connect the front brake cable and make the adjustment with the adjusting nut ① at the brake arm. Adjust so that there is 10 mm to 20 mm (0.40~0.80 in) of free travel at the brake lever. (Fig. 4.17)

#### 4.2 STEERING STEM

##### A. Construction

The steering stem is the pivot point for the front wheel and is supported in the frame head pipe by two sets of cone races and steel balls.

It is made of high strength heat treated steel to withstand the shock imposed by rough roads and also the high frequency vibration which tends to fatigue the metal.

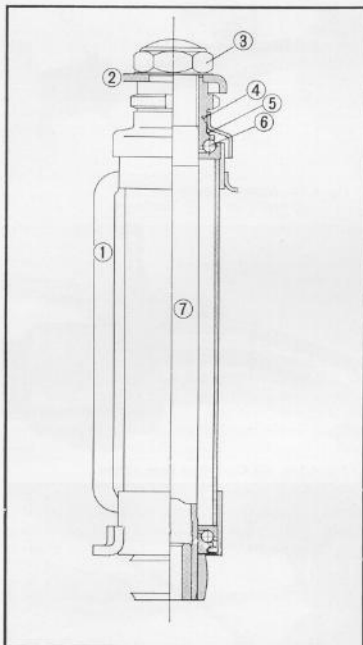

Fig. 4.18 A Steering stem section diagram (S90, CL90, CL90L)  
 ① Frame  
 ② Fork top bridge plate  
 ③ Steering stem nut  
 ④ Steering head top thread  
 ⑤ Cone race  
 ⑥  $\frac{3}{16}$  steel ball  
 ⑦ Steering stem

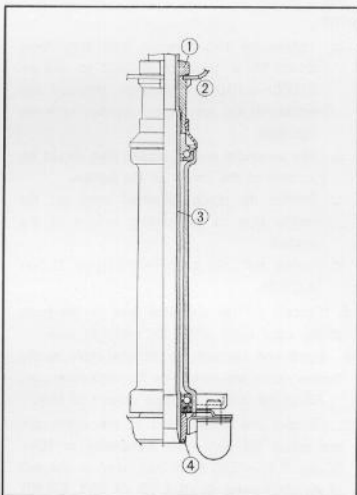

Fig. 4.18 B Steering stem section diagram (C90)  
 ① Steering head stem nut  
 ② Fork top bridge  
 ③ Steering stem  
 ④ Front fork bottom bridge

**B. Disassembly**

(S 90, CL 90, CL 90 L)

1. Disassemble the handle and the top bridge plate ① in accordance with 4.1.B. (Fig. 4.19)

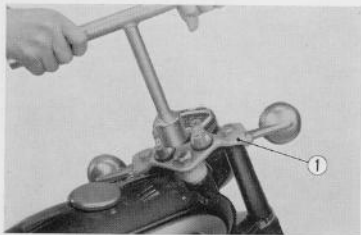

Fig. 4.19 Removing fork top bridge plate  
① Fork top bridge plate

2. Disassemble the front cushion ① in accordance with 4.3.B. (Fig. 4.20)
3. The horn assembly is removed from the fork bottom bridge by removing the two 6×12 hex bolts.

(The horn may be removed either before or after the removal of the steering stem)

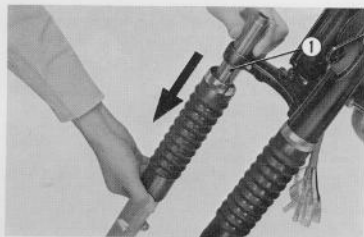

Fig. 4.20 Removing front cushion  
① Front fork

4. Remove the steering head top thread ② using a 36 mm hook spanner ① (tool No. 07072~00101) and pull the steering stem out the bottom. (Fig. 4.21)

**CAUTION:**

Do not drop out the # 6 steel balls during the steering stem removal.

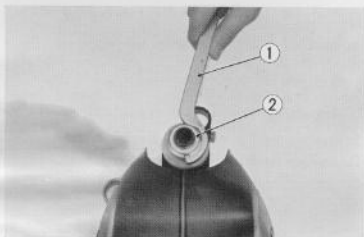

Fig. 4.21 Removing steering head top thread  
① 36 mm hook spanner  
② Steering head top thread

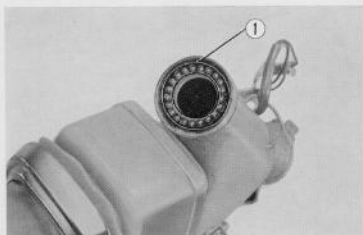

Fig. 4.22 Steel balls  
① #6 steel balls

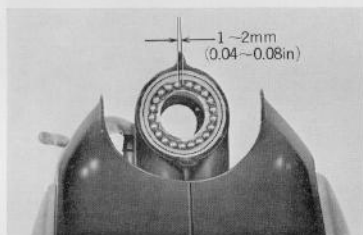

Fig. 4.23 Steel balls

#### (CD 90, C 90, CT 90)

1. For disassembly, refer to the respective front fork removal for CD90, C90 and CT 90 in 4.3.B.

#### CAUTION:

When removing the front fork, caution not to drop steel balls installed in the steering head. (Fig. 4.22)

#### (CT 90 Model From Frame No. 000001A)

1. Remove the handle lever in accordance with section 4.1.B (CT 90).
2. Unscrew the two front fork bolts and the steering stem nut and remove the fork top bridge.
3. Unscrew the two headlight mounting bolts and remove the headlight and then the left and right front fork cover.
4. Remove the front fender.
5. Raise the front wheel and place a stand under the engine unscrew the front axle nut, pull out the axle and remove the front wheel.
6. Loosen the front cushion mounting bolt on the front fork bottom bridge and drop the front fork assembly.
7. Loosen the steering head top thread using the 36 mm hook spanner and remove the steering stem out the bottom.

#### Note:

Exercise care not to drop the steel balls when removing the steering stem.

#### C. Inspection

1. Inspect the #6 steel balls for crack and wear.
2. Inspect steering stem for bend and twist.
3. Inspect the steering bottom and top cone races and ball races for scratches, wear and streaks.

#### D. Reassembly

1. Wash the cone and ball races and the steel balls, and pack with recommended new fiber grease.

#### NOTE:

The gap left after all 21 of the steel balls are installed should be between 1 to 2 mm (0.040~0.080 in) (Fig. 4.23)

2. Perform the reassembly in the reverse procedure of disassembly.

Exercise caution on the following points.

- (1) Do not drop the steel balls during the insertion of the steering stem.
- (2) Steering stem should be tightened so that only a slight pressure is required to start the wheel moving to either side under its own weight while raising the wheel off the ground, however, it should not be loose to the extent that excessive clearance is evident in the vertical side, and fore and aft direction when checked with the wheel raised off the ground.



## 4.3 FRONT FORK

## A. Construction

The function of the front cushion is to provide good steering characteristics and together with the rear cushion afford comfortable riding. The front fork, in particular, must prevent the vibration of the front wheel created by the rough road condition from being transmitted to the rider. It must be made sturdy to withstand the high loads imposed. (Fig. 4. 24)

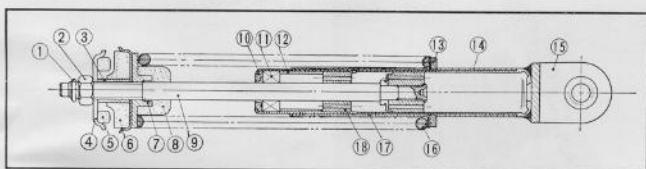

Fig. 4. 24 A Front cushion sectional diagram (C 90)

- |                                |                              |
|--------------------------------|------------------------------|
| ① 6 m/m lock pin               | ⑩ Roll stake all around      |
| ② 7 m/m lock nut               | ⑪ Front damper oil seal      |
| ③ Front cushion upper collar   | ⑫ Front damper inner collar  |
| ④ Front cushion joint washer   | ⑬ Front damper end plate     |
| ⑤ Front cushion joint rubber B | ⑭ Front cushion outer collar |
| ⑥ Front cushion joint rubber A | ⑮ Bottom metal complete      |
| ⑦ Front cushion lock nut       | ⑯ Front cushion spring       |
| ⑧ Front cushion stopper rubber | ⑰ Front cushion spring guide |
| ⑨ Front cushion rod complete   | ⑱ Front damper rod guide     |

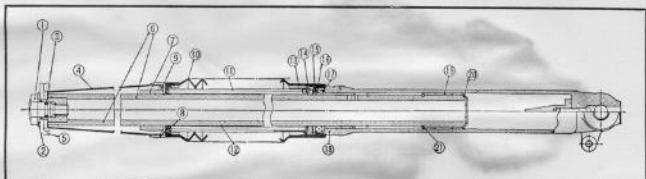

Fig. 4. 24-B Front cushion [S 90, CL 90, CL 90 L, CI 90 (from F. No. 000001A)]

- |                                 |                                    |
|---------------------------------|------------------------------------|
| ① Front fork bolt               | ⑲ Front cushion spring guide       |
| ② 13.2×24 washer                | ⑳ Front cushion under spring guide |
| ③ 8.4×2.4 O ring                | ㉑ Front cushion spring under seat  |
| ④ Front fork cover              | ㉒ 37 m/m circla                    |
| ⑤ Fork top bridge plate         | ㉓ Front fork oil seal              |
| ⑥ Front fork pipe               | ㉔ Front fork pipe guide            |
| ⑦ Fork bottom bridge            | ㉕ Front fork bottom pipe           |
| ⑧ Fork cover lower seat         | ㉖ Front fork piston                |
| ⑨ Fork cover lower seat packing | ㉗ Front fork piston snap ring      |
| ⑩ Front fork boot               | ㉘ Piston stopper ring              |
| ⑪ Front cushion spring          |                                    |



Fig. 4.25 Removing headlight ① 8×22 hex bolt

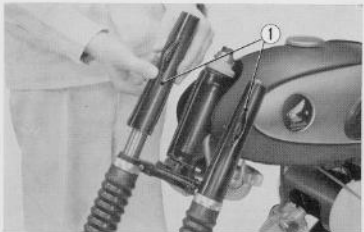

Fig. 4.26 Removing front fork cover ① Front fork cover

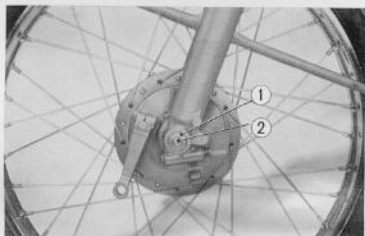

Fig. 4.27 Removing front wheel  
① Front wheel axle nut ② Front wheel axle

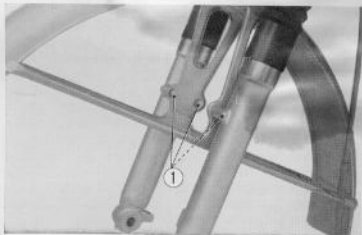

Fig. 4.28 Removing front fender ① 6 mm setting bolt

### B. Disassembly

(S 90, CL 90, CL 90 L)

1. Disassemble the steering handle in accordance with 4.1.B.
2. Remove the speedometer cable cap from the front brake panel, remove the two 8×22 hex bolts ① from both sides of the headlight and remove the headlight body. (Fig. 4.25)
3. Remove the left and right front fork covers ①. (Fig. 4.26)
4. Place an adequate stand below the engine to raise the front wheel. Remove the front wheel axle nut ① and pull out the front axle ②. Then, the front wheel will drop away. (Fig. 4.27)
5. Remove the front fender by removing 2 hex bolts ① from each side. (Fig. 4.28)

- Remove the two front cushion setting bolts at the front fork bottom bridge and remove the front cushions ①. (Fig. 4.29)

**CAUTION:**

Before removing the front cushions, mark the front fork pipe.



Fig. 4.29 Removing front fork assembly  
① Front fork

- Drain the oil in the cylinder by removing the drain plug before disassembly of the lower cylinder.
- Disassemble the fork assembly by removing the lower cover seat packing, lower cover seat, boot, coil spring and spring guide.
- Use a snap ring pliers to remove the 37 mm internal circlip. Separate the fork piston and stop ring from the fork bottom pipe.

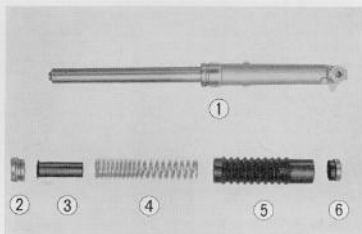

Fig. 4.30 Component parts of front fork

- Front fork complete
- Fork cover lower seat
- Front cushion spring guide
- Front cushion spring
- Front fork boot
- Front cushion under spring seat

**(CD 90 & CT 90)**

- Remove the handle and the fork top bridge in accordance with section 4.1.B.
- Remove the headlight case ① by removing the two 6×25 hex bolts ② within the headlight case and the 6×40 cross screw. (Fig. 4.31)

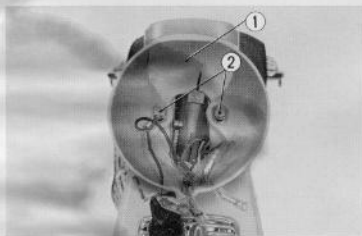

Fig. 4.31 Removing headlight case

- Headlight case
- 6×22 hex bolt

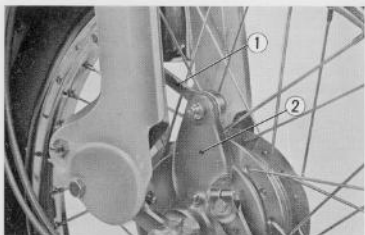

Fig. 4.32 Disconnect front brake torque link  
① Front brake torque link ② Front brake panel



Fig. 4.33 Removing front wheel  
① 8×22 hex bolts ② front wheel axle

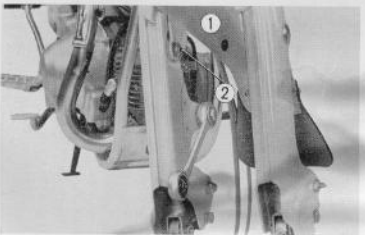

Fig. 4.34 Removing front fender (CT 90)  
① Front fender ② 8 mm hex nut

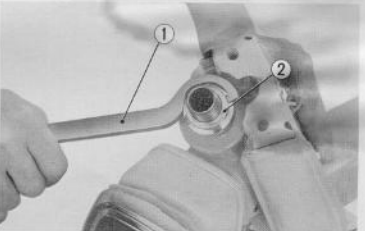

Fig. 4.35 Removing steering head top thread (CT 90)  
① 36 mm hook spanner ② Steering head top thread

3. Place a suitable stand under the engine and remove the front brake torque link ① from the front brake panel ②. (Fig. 4.32)

4. Remove the front axle nut and the 8 mm hex bolts ① at the front suspension arm and pull out the front axle ② from the opposite side; the front wheel will drop out. (Fig. 4.33)

5. Remove the front fender ① by removing the two 8 mm hex nuts ②. (CT 90) (Fig. 4.34)

Remove the front fender by removing the two 8 mm hex nuts and the two castle nuts. (CD 90)  
(Front fork can be removed without taking off the front fender)

6. Using a 36 mm hook spanner ① (Tool No. 07072~00101) remove the steering head top thread ②. (Fig. 4.35)

7. The front fork ① can be removed together with the front cushions by sliding out the bottom.

(Fig. 4.36)

8. To disassemble the front cushion, loosen the 8 mm self locking nut and remove the front arm pivot bolt. And remove the front cushion upper bolts by removing the 18 mm jam nuts, the 8 mm hex bolts fixing the rebound stoppers.

Then, the front cushion (Fig. 4.37) can be removed together with the front suspension arms from the front fork.

9. Remove the front cushion under bolt by removing the 8 mm hex nut, then the front cushion ① can be disassembled from the suspension arm ②. (Fig. 4.38)

**CAUTION:**

- When separating the front suspension arm from the front cushion, care should be taken to prevent the front cushion lower dust seal cap, dust seal and distance collar from dropping.
  - Remove the pivot dust seal by unlocking the staking and remove the dust seal and pivot collar.
10. The front cushion disassembly can be performed by removing the front cushion lock nut and then removing the front cushion spring.

**CAUTION:**

The front damper bottom metal should not be disassembled as it requires special tools and the component parts are not sold individually.

**(CT 90 Model From Frame No. 000001A)**

- Remove the front fork assembly from the frame in accordance with section 4.2.B (CT 90).
- Disassemble the boot, spring guide, front cushion spring and etc. from the front fork assembly.
- Remove the 37 mm circlip and separate the front fork pipe from the front fork bottom case.

**(C 90)**

- Remove the steering handle in accordance with 4.1.B.
- Place a suitable stand under the engine to raise the front wheel.  
Remove the front brake torque bolt by removing the 8 mm self locking nut. Remove the axle nut and pull out the front wheel axle from the opposite side, then, the front wheel will drop out.
- Using a 36 mm hook spanner remove the steering head top thread and draw the front fork out of the head pipe.
- Remove the 6 mm lock pin and 7 mm lock nut, and then the front cushion joint washer and the joint rubber can both be removed.

Next, by removing the front arm pivot bolt and 8×42 hex bolt, the front cushion and the front



Fig. 4.36 Removing front fork  
① Front fork

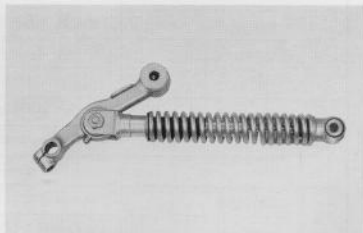

Fig. 4.37 Front cushion assembly (CT 90)

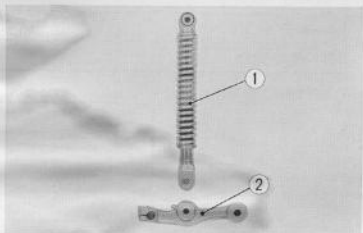

Fig. 4.38 Front cushion  
① Front cushion  
② Front arm

suspension arm can be removed together from the front fork. The front arm rebound stopper can next be removed.

- By removing the 8 mm bolt and the front cushion lower bolt, the front cushion and the front suspension arm can be separated.

### C. Inspection

- Check the front cushion spring

	Item	Standard value	Serviceable limit
S 90	Free length	197.7 mm (7.789 in)	Replace if under 178 (7.013 in)
	Loading	16.97 mm/10.2 kg (6.686 in/22.44 lbs)	—
	Tilt	Within 1°	
CL 90 CL 90 L	Free length	197.7 mm (7.789 in)	Replace if under 178 (7.013 in)
	Loading	16.97 mm/10.2 kg (6.686 in/22.44 lbs)	—
	Tilt	Within 1°	
CD 90	Free length	149.5 mm (5.886 in)	Replace if under 135.0 mm (5.32 in)
	Loading	117 mm/76 kg (4.606 in/167.58 lbs)	—
	Tilt	Within 1°	
C 90	Free length	133.4 mm (5.2520 in)	Replace if under 120 mm (4.73 in)
	Loading	112.6 mm/47.5~52.5 kg (4.433 in/104.736 115.763 lbs)	—
	Tilt	Within 1°	
CT 90 (from frame No. 000001A)	Free length	203 mm (8.0 in)	Replace if under 185 mm (7.3 in)
	Loading	119.6 mm/23.5~26.5 kg (4.71 in/51.7~58.3 lbs)	
	Tilt		

- Damping capacity

Model	Damping Capacity
S 90	10 kg/0.5 m/sec (22.1 lbs/20 in/sec)
CL 90 L	"
CD 90	"
C 90	"
CT 90	"

- Dimensions

Item	Standard value	Serviceable limit
S 90 Front fork piston (CT 90 from frame No. 000001A)	30.950~30.975 (1.219~1.220 in)	Replace if under 30.85 (1.215 in)
Front fork bottom case	31.00~31.039 (1.22~1.223 in)	Replace if over 31.10 (1.225 in)
CL90, CL90L Front fork piston	30.950~30.975 (1.219~1.220 in)	Replace if under 30.85 (1.215 in)
Front fork bottom case	31.00~31.039 (1.221~1.223 in)	Replace if over 31.10 (1.225 in)

4. Inspect dust seal, bushings and shafts for wear and damage; replace as necessary.

#### D. Reassembly

Reassemble the front fork in the reverse order of disassembly.

(CT 90 Model From Frame No. 000001A)

After reassembly of the front fork on CT 90, fill with 130~140 cc (8.0~8.6 cu.in.) of good grade SAE 10W-30 oil from the front fork bolt hole.

### 4.4 FUEL TANK

#### A. Construction

The fuel tank ① is mounted on the frame and ahead of the seat on the S90, CL90, CL90L and CD90. On the C90 and CT90, it is located below the seat and is the structure on which the seat is mounted. (Fig. 4.39 A, B)

#### B. Disassembly

(S 90, CL 90, CL 90 L, CD 90)

1. Turn off the fuel cock ① at the bottom of the tank and disconnect the fuel line. (Fig. 4.40)
2. Remove the seat setting nuts ① and remove the seat ②. (Fig. 4.41)



Fig. 4.39 A Fuel tank (CT 90) ① Fuel tank



Fig. 4.39 B Fuel tank (CL 90) ① Fuel tank

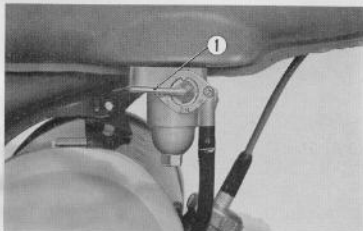

Fig. 4.40 Turn off the fuel cock ① Fuel cock

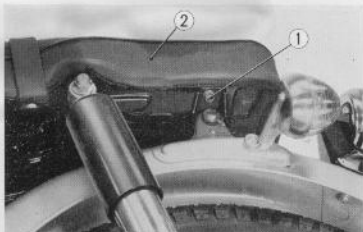

Fig. 4.41 Removing seat setting nuts  
① Seat setting nut ② Seat



Fig. 4.42 Removing fuel tank ① Fuel tank

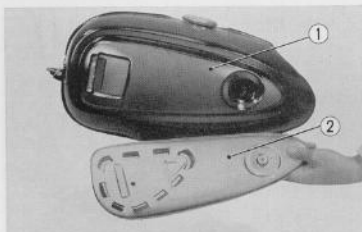

Fig. 4.43 Removing tank side cover  
① Fuel tank ② Tank side cover

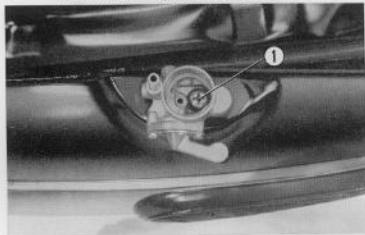

Fig. 4.44 Removing fuel cock  
① Fuel cock mounting screw



Fig. 4.45 Removing fuel tank  
① Fuel tank mounting bolt ② Fuel tank

3. Withdraw the fuel tank ① from the rear, raising it slightly. (Fig. 4.42)

4. To remove the tank side cover ②, remove the two screws on the emblem and then unscrew the side cover bolt. Slide the cover forward to remove. (Fig. 4.43)

5. The fuel cock can be removed by first unscrewing the fuel strainer cap, removing the filter screw and then the cross pin fuel cock mounting screw. ① (Fig. 4.44)

#### (C 90, CT 90)

1. Turn off the fuel cock, disconnect the fuel line and drain the fuel from the tank.
2. Unscrew the tank mounting bolts ① located at both side of the tank and lift off the tank. (Fig. 4.45)

#### C. Inspection

1. Flush the inside of the tank to remove any scales or other foreign matter.
2. Make sure that there are no leaks in the tank.



### D. Reassembly

Perform the reassembly in the reverse order of disassembly.

**NOTE:** (S 90, CL 90, CL 90 L, CD 90)

- 1) Make sure that the fuel cock gasket is in good condition before installation; also that the fuel seal packing is on the fuel cock mounting screw.
- 2) Use the proper size bolt (6×10mm hex bolt) ① to install the side cover on the tank. Long bolt will bottom on the tank and result in puncture. (Fig. 4.46)

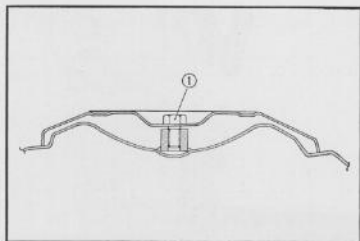

Fig. 4.46 Cross-sectional view of side cover installation  
① 6×10mm hex bolt

## 4.5 FRAME BODY

### A. Construction

The frame is the backbone of the motorcycle and it is about this that the motorcycle is designed.

Further it is the very important factor in determining the motorcycle styling.

The most important function of the frame is providing the necessary strength to the entire motorcycle. It supports the engine, the rider, cargo and through the tires and cushion, must withstand the shocks produce by travelling over rough road.

Further, from the standpoint of steering, high degree of rigidity is required and on the other hand, lightness is desired for riding performance. (S 90, CL 90, CL 90 L) (Fig. 4.47)

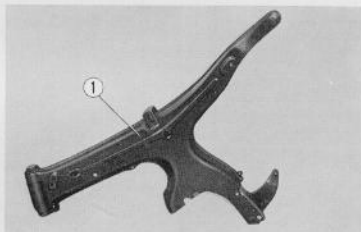

Fig. 4.47 ① Frame body (S 90, CL 90)

Model	Type frame construction
S 90, CL 90, CL 90 L	T. Bone type—pressed sheet steel
CD 90	Conventional type—pressed sheet steel
CT 90, C 90	Step through type—pressed sheet steel and pipe

### B. Disassembly

1. Remove the engine in accordance with section 3 a.
2. Disassemble the frame body in accordance with the section 4.
3. Remove the main ignition switch ② from the left center of the frame using the main switch hook spanner ① (Tool No. 07071~25001) (Fig. 4.48)

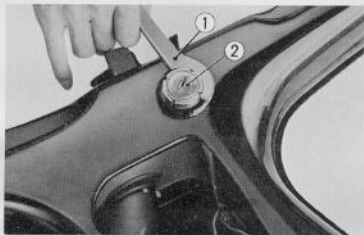

Fig. 4.48 Removing main ignition switch  
① Main switch hook spanner  
② Main ignition switch

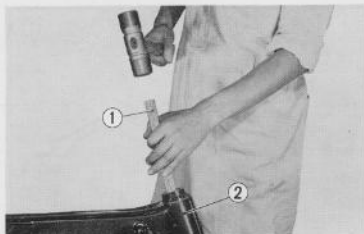

Fig. 4.49 Removing ball races  
① Drift ② Head pipe

4. Remove the selenium rectifier, ignition wire harness and the stop switch assembly from the frame body.
5. Remove the steel balls and drive out the ball races from inside the steering head pipe ② with a wooden or fiber drift ①. (Fig. 4.47)

#### C. Inspection

1. Inspect the areas around the frame for separation, buckling around the head pipe and other damages.
2. Inspect the angle of the head pipe and for distortion.
3. Inspect the top and bottom ball races for galling, wear and damage.

#### NOTE:

The fit between the ball races and the head pipe is  $-0.003 \sim +0.003$  ( $-0.0001 \sim +0.0001$  in).

When driving out the ball race, make sure that they are driven out uniformly.

4. Inspect the frame for buckles, damages and the condition of the paint.

#### D. Reassembly

1. Install the ball race by driving it in straight without tilting.
2. Mix the steel balls in grease and lay the 21 balls into the top and the bottom ball races.
3. Install the respective electrical equipment in the reverse order of disassembly.

### 4.6 SEAT

#### A. Construction

The seats on all the model are provide with extra padding for added comfort.

Further, all the seats are tandem with the exception of the CT 90 which is single.

A tool box is mounted on the bottom of the seat right side for S 90, CL 90 and CL 90 L.

#### B. Disassembly

(S 90, CL 90, CL 90 L)

1. Unscrew the two seat mounting nuts ① located under the seat. (Fig. 4.50)

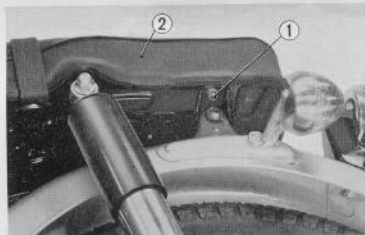

Fig. 4.50 Removing seat mounting nut  
① 6 mm nut  
② Seat

2. Remove the seat ① by pulling up and back toward the rear. (Fig. 4.51)

(CD 90)

1. Loosen the upper rear cushion mounting cap nuts ① from the right and left side. (Fig. 4.52)
2. Remove the seat by pulling up and back toward the rear.

(CT 90, C 90)

Raise the seat ① and detach the seat at the hinge by removing the seat hinge pin. ② (Fig. 4.53)

#### C. Inspection

1. Check the seat covering for tears, broken seams or other damages.
2. Clean the covering with soap and water. Do not use any harsh chemical as it will deteriorate the covering.

#### D. Reassembly

1. Assemble the seat in the reverse procedure of disassembly described in section 4.6 B.
2. The tool box ① for the S 90, CL 90 and CL 90 L is attached to the bottom, right side of the seat. Tighten the wing lock nut to prevent loss. (Fig. 4.54)

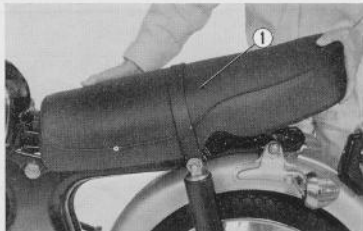

Fig. 4.51 Removing seat ① Seat

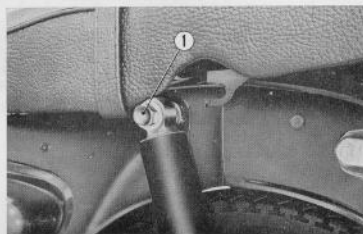

Fig. 4.52 Loosen upper rear cushion cap nuts  
① Rear cushion cap nut



Fig. 4.53 Removing seat hinge pin  
① Seat ② Seat hinge pin

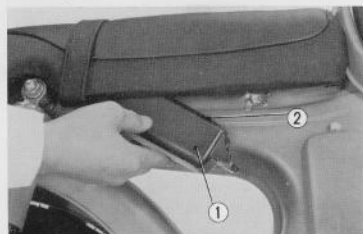

Fig. 4.54 Tool box ① Tool box ② Tool kit

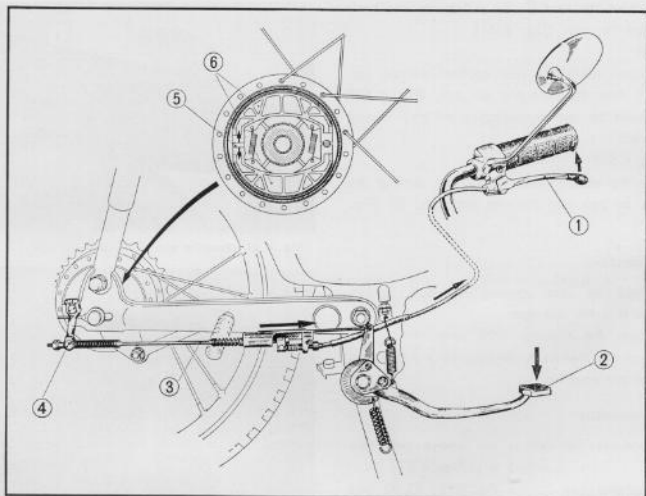

Fig. 4.55 Rear brake operation

- |                    |                    |
|--------------------|--------------------|
| ① Rear brake lever | ④ Rear brake arm   |
| ② Rear brake pedal | ⑤ Rear brake cam   |
| ③ Rear brake rod   | ⑥ Rear brake shoes |

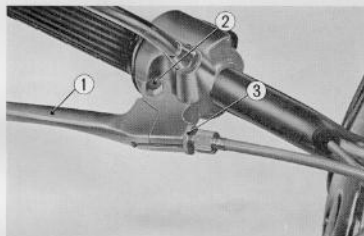

Fig. 4.56 Removing front brake lever

- |                      |
|----------------------|
| ① Front brake lever  |
| ② Pivot screw        |
| ③ Adjusting lock nut |

## 4.7 BRAKE SYSTEM

### A. Construction

Good brakes are the most important item required for safe riding. They should always be maintained in the best of condition.

The front brake is operated by the right hand steering handle lever and the rear brake by the right foot pedal.

The rear brake on the CT 90 can be operated either by the right foot pedal or the left hand steering handle lever. (Fig. 4.55)

### B. Disassembly

#### 1. Front wheel brake (all model)

- (1) To remove the front brake lever ①, remove the handle lever pivot screw ② and remove the front brake cable by aligning the grooves in the handle lever and the nut ③. (Fig. 4.56)

- (2) By removing the adjusting nut at the front wheel, the front brake cable ① can be removed from the front brake arm joint. (Fig. 4.57)

- (3) Front brake panel  
(S 90, CL 90, CL 90 L)

Remove the front brake cable ① and the speedometer cable ② from the front brake panel. Remove the axle nut ③ and pull out the axle ④, then the front brake panel can be removed together with the front wheel. (Fig. 4.57)

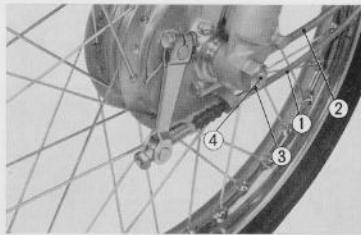

Fig. 4.57 Removing front brake cable

- ① Front brake cable  
② Speedometer cable  
③ Axle nut  
④ Front wheel axle

(CD 90, C 90, CT 90)

- (4) Disconnect the speedometer cable ① and front brake cable ②, remove the castle nut ④ and pull out the panel stopper bolt ⑤. Then loosen the two 8 mm hex bolts ⑥, at the suspension arm, and remove the axle nut and pull out the axle ③.

The front wheel will drop out from the front fork. (Fig. 4.58)

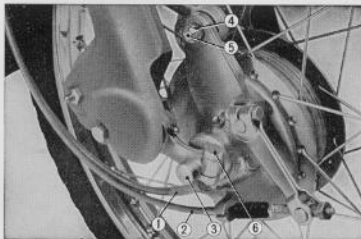

Fig. 4.58 Removing front brake cable

- ① Speedometer cable  
② Brake cable  
③ Front axle  
④ Castle nut  
⑤ Panel stopper bolt  
⑥ 8 mm-hex bolt

- (5) The front brake shoes ① shall be removed from the panel ② by spreading the shoes against the brake shoes spring pressure and pulling out. (Fig. 4.59)

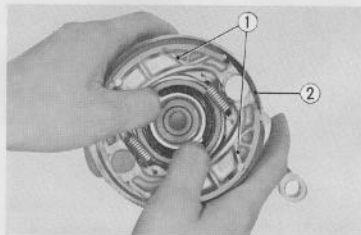

Fig. 4.59 Removing front brake shoes

- ① Front brake shoes  
② Front brake panel

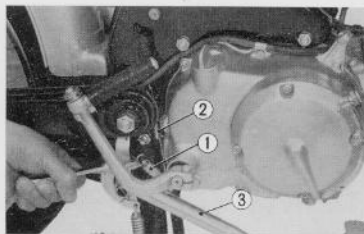

Fig. 4.60 Removing brake pedal and stop light springs

- ① Brake pedal spring
- ② Stop light spring
- ③ Brake pedal

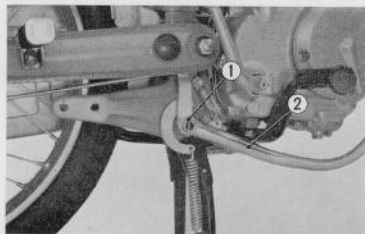

Fig. 4.61 Removing 3 mm cotter pin.

- ① 3 mm cotter pin
- ② Rear brake pedal

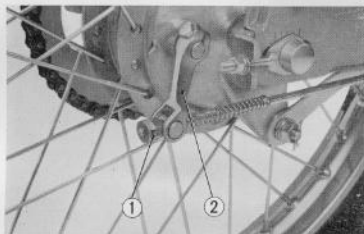

Fig. 4.62 Removing rear brake rod from rear brake arm

- ① Brake adjusting nut
- ② Brake arm

## 2. Rear brake pedal.

(S 90, CL 90, CL 90 L)

- (1) Remove the muffler. (For CL 90 and CL 90 L removal of muffler will not required.)
- (2) Remove the brake pedal spring ① and the stop light spring ② from the brake pedal ③. (Fig. 4.60)
- (3) Remove the 3 mm cotter pin ① from the rear brake pivot pipe (Fig. 4.61)
- (4) Remove the rear brake adjusting nut and remove the brake rod from the rear brake arm.

(Alternate method is to remove the 1.6 × 15 cotter pin at the rear brake pedal and rear brake rod joint.)

- (5) The rear brake pedal can be removed by pushing the rear brake pivot pipe into the hole by tapping with a rod and a hammer. (CD 90 & C 90)

(1) Remove the muffler.

- (2) Remove the brake pedal spring and the stop light spring from the brake pedal.
- (3) Remove the rear brake adjusting nut and remove the brake rod from the brake arm.
- (4) Remove the 6 mm nut from the rear brake and rear brake pivot pipe and remove the cotter pin from the opposite end.

(The removal can be performed more easily with the drive chain case lower half removed.)

- (5) By removing the rear brake pivot pipe, the brake pedal can be removed.

### CAUTION:

The rear brake pivot pipe is commonly used for the main stand, therefore, before removing the rear brake pivot bolt place a suitable stand under the engine.

- (6) Rear wheel disassembly (refer to section 4.13)

The rear wheel can be disassembled in the same manner as with S 90.

## (CT 90)

### 1. Brake pedal disassembly

- (1) Remove the brake pedal spring and the stop light spring from the brake pedal.
- (2) Remove the brake adjusting nut ① and remove the rear brake rod from the rear brake arm ②. (Fig. 4.62)

- (3) Remove the rear brake cable ① from the brake rod ②. (Fig. 4.63)
- (4) Remove the 8 mm jam nut from the rear brake pipe and remove the cotter pin at the opposite end.

By pulling out the rear brake pipe, the brake pedal can be removed together with the brake rod.

## 2. Rear wheel disassembly

- (1) For disassembling the rear wheel, refer to section 4.13.

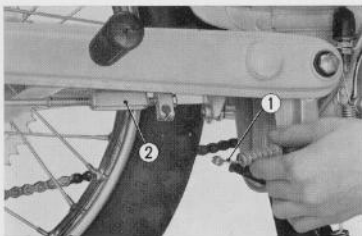

Fig. 4.63 Removing rear brake cable

- ① Rear brake cable
- ② Brake rod

## 4.8 MUFFLER

### A. Construction

The muffler and exhaust pipe have been made into an integral unit by welding to greatly improve the silencing effectiveness of the muffler. The noise is further reduced by the incorporation of a diffuser pipe at the muffler outlet.

### B. Disassembly

(all model)

1. Remove the two flange mounting nuts from the exhaust pipe flange at the cylinder head.
2. Remove the nuts attaching the muffler brackets to the frame at several points.

The location of the brackets will vary between the different models.

3. The diffuser pipe can be removed by unscrewing the  $6 \times 8$  hex bolt, however, the diffuser pipe is not removable on the USA export models. (Fig. 4.65)

### C. Inspection

1. Inspect the muffler and exhaust pipe for burnt through spots, large dents which may effect performance.
2. Tap the muffler all around lightly with a wooden rod and shake out the loosened carbon particles.

### D. Reassembly

1. Position the muffler unit in place, making sure that the gasket is installed, and first install the exhaust pipe flange to the cylinder head temporarily.
2. Tighten the bracket bolts and the finally tighten the flange.



Fig. 4.64 S90

- ① Muffler

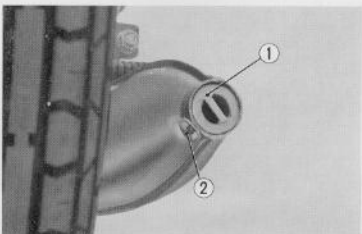

Fig. 4.65 Removing diffuser pipe

- ① Diffuser pipe
- ②  $6 \times 8$  hex bolt

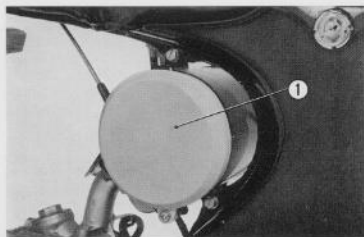

Fig. 4.66 Air cleaner (S 90)  
① Air cleaner



Fig. 4.67 Removing air cleaner mounting bolts (S 90)  
① Air cleaner case cover  
② Air cleaner mounting bolt

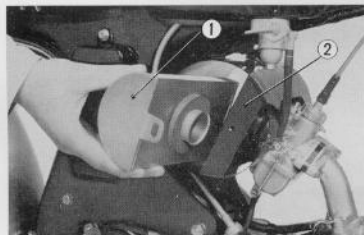

Fig. 4.68 Removing air cleaner (S 90)  
① Air cleaner element  
② Air cleaner case

## 4.9 AIR CLEANER

### A. Construction

The air cleaner contains a paper filter element which is corrugated to provide the maximum of filtering surface. It is designed to provide the carburetor with the greatest volume of air and a least amount of dust, assuring maximum power output and endurance from the engine.

The air cleaner is supported on the frame and enclosed so that it is adequately protected from the rain, dust and other adverse elements.

On the S 90, CL 90 and CL 90 L, the filter is located at the center of the frame below the fuel tank (Fig. 4.66). For the CD 90, the filter is located on the left side frame center. For the C 90 and CT 90 the filter is located in the vicinity of the steering stem.

### B. Disassembly

(S 90, CL 90, CL 90 L)

1. Remove the air cleaner case cover screws, one each on the right and left side and take off the cover ①. Unscrew the air cleaner mounting bolt ②. (Fig. 4.67)
2. Remove the two air cleaner case mounting screws, upper and lower, and detach the air cleaner case.
3. Remove the air cleaner connecting tube clamp from at the cleaner end through the air cleaner connecting tube groove. Free the air cleaner element by pushing toward the rear and when disengaged from the tube, slide the element ① out of the case. (Fig. 4.68)



**(CD 90)**

Remove the air cleaner case cover ① mounted on the right side at the center of the frame. The air cleaner element may be removed by unscrewing the attaching screw ③. (Fig. 4.69)

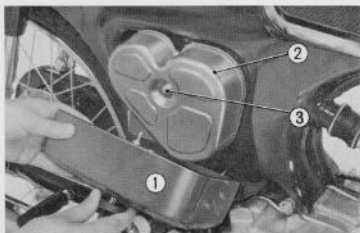

Fig. 4.69 Removing air cleaner (CD 90)

- ① Air cleaner cover
- ② Air cleaner case
- ③ Attaching screw

**(C 90, CT 90)**

Unscrew the cap nut ①, remove the cover ② and pull out the cleaner element. (Fig. 4.70)

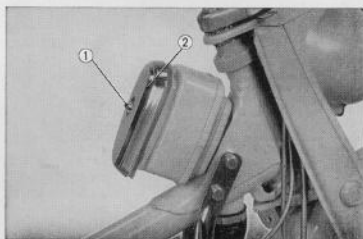

Fig. 4.70 Removing air cleaner (C 90, CT 90)

- ① Cap nut
- ② Air cleaner cover

**C. Inspection**

1. Replace any element which is deformed or damaged.
2. Clean the element ① by first tapping lightly to loosen the dust and then blow off the dust by applying dry compressed air from the inside. (Fig. 4.71)

**CAUTION**

All loose dust must be removed completely or else the dust will be taken into the cylinder and cause wear.

**D. Reassembly**

Perform the reassembly in the reverse order of disassembly.

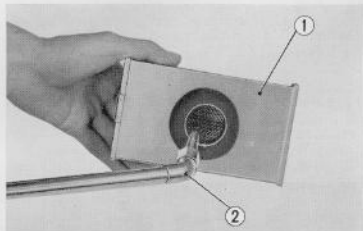

Fig. 4.71 Cleaning air cleaner

- ① Air cleaner element
- ② Air gun

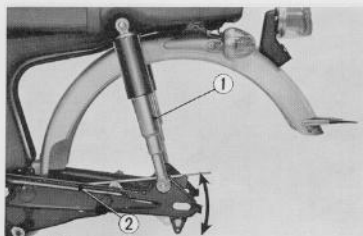

Fig. 4.72 Rear fork  
① Rear cushion ② Rear fork



Fig. 4.73 Removing rear wheel ① Rear wheel

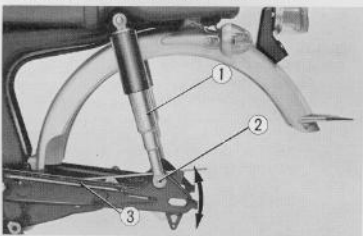

Fig. 4.74 Removing lower bolt  
① Rear cushion ② Rear cushion lower bolt  
③ Rear fork

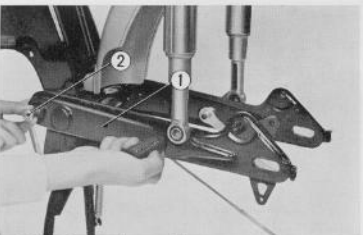

Fig. 4.75 Removing rear fork  
① Rear fork ② Rear fork pivot bolt

#### 4.10 REAR FORK AND CUSHION DAMPER

##### A. Construction

The rear fork is a swinging arm type design supported by a spring cushion damper at the rear and hinged at the front to the main frame member. When the rear wheel is in motion, the fork pivot about this hinge point.

This hinge point is close enough to the chain drive sprocket that the movement of the wheel has very little effect on the chain tension.

##### B. Disassembly

1. Set the motorcycle up on the main stand and remove the rear wheel (refer to section 4.13B).  
Remove the drive chain case on the model which are so equipped.
3. Remove the rear cushion damper lower bolt and detach the damper from the rear fork.
4. Remove the rear fork pivot bolt and separate the fork from the frame.

##### C. Inspection

1. Damaged or worn drive chain case gasket should be replaced.
2. Check the rear fork pivot rubber bushing for damage, excessive wear and aging.

Item	Standard value	Serviceable limit
S 90, CL 90, CL 90 L	12.0~12.2 (0.472~0.480 in)	
CD9 0, C 90, CT 90		

3. Check the rear fork for alignment, replace if twisted greater than 1 mm (0.040 in).

##### D. Reassembly

1. Assemble fork in the reverse order of disassembly.
2. Install the wheel and drive chain, and adjust the chain tension.

## 4.11 REAR FORK CUSHION DAMPER

## A. Construction

The rear fork cushion damper is a coil type with a double cylinder oil type damper. The shock is received by the damper and the reaction is dissipated by the oil damper. The oil damper contains 30 cc. of SAE #30 straight mineral (paraffin) oil.

The specified amount is important, since the shock damping effect is either increased or diminished in proportion to the amount of fluid. (Fig. 4.76)

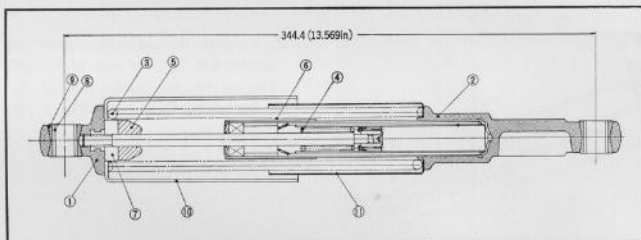

Fig. 4.76 A Sectional view of rear cushion (5 90, CL 90, CL 90 L)

- |                                       |                                   |
|---------------------------------------|-----------------------------------|
| ① Rear cushion upper metal            | ⑦ Rear cushion lock nut           |
| ② Rear cushion bottom metal           | ⑧ Rear cushion rubber bush collar |
| ③ Rear cushion spring                 | ⑨ Rear cushion rubber bush        |
| ④ Rear cushion rebound stopper spring | ⑩ Rear cushion upper case         |
| ⑤ Rear cushion stopper rubber         | ⑪ Rear cushion under case         |
| ⑥ Rear cushion spring guide           |                                   |

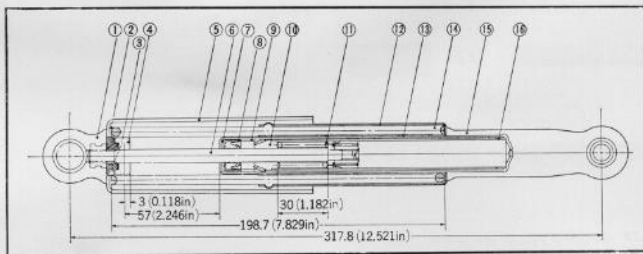

Fig. 4.76 B Rear cushion (C 90, CT 90)

- |                               |                                       |
|-------------------------------|---------------------------------------|
| ① Rear cushion upper metal    | ⑩ Rear cushion collar                 |
| ② 24 mm washer                | ⑪ Rear damper rod guide               |
| ③ Rear cushion upper lock nut | ⑫ Rear cushion rebound stopper spring |
| ④ Rear cushion stopper rubber | ⑬ Rear cushion bottom case            |
| ⑤ Rear cushion upper case     | ⑭ Rear cushion spring guide           |
| ⑥ Rear damper rod complete    | ⑮ Rear cushion spring                 |
| ⑦ Rear cushion end plate      | ⑯ Rear cushion bottom metal complete  |
| ⑧ Rear cushion oil seal       | ⑰ Rear cushion inner pipe             |

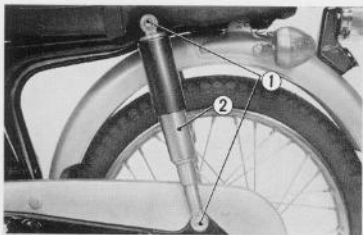

Fig. 4.77 Removing rear cushion

- ① 8 mm cap nuts
- ② Rear cushion

#### B. Disassembly

1. Remove the 8 mm upper and lower cap nuts ①. Remove the rear cushion assembly ②. (Fig. 4.77)

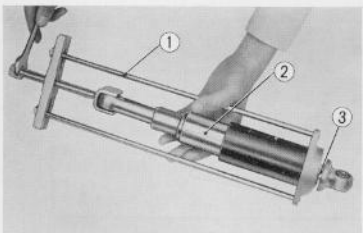

Fig. 4.78 Disassembling rear cushion

- ① Rear cushion disassembly and assembly tool
- ② Rear cushion
- ③ Rear cushion lock nut

2. Compress the rear cushion upper case with a special tool ① (tool No. 07035-03301) and take out the rear cushion lock nut ③. Remove the upper case. (Fig. 4.78)

3. Remove the rear cushion components parts. (Fig. 4.79)

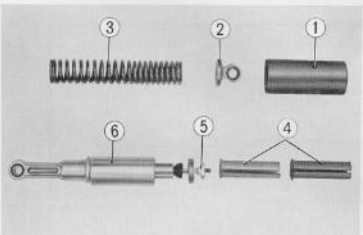

Fig. 4.79 Component parts of rear cushion

- ① Rear cushion upper case
- ② Rear cushion upper metal
- ③ Rear cushion spring
- ④ Rear cushion rod case
- ⑤ Rear cushion locking nut
- ⑥ Rear cushion bottom metal

## C. Inspection

### 1. Damping capacity

Model	Damping capacity	Damping fluid	Cushion length	Stroke
S 90	25~35 kg/0.5 m/sec (55.125~77.175 lbs/19.68 in/sec)	Spindle oil #60	Max 348 (13.70 in) Min 296.8 (11.30 in)	61.1 (2.41 in)
CL 90 ,CL 90 L	"	"	Max 348 (13.70 in) Min 294.4 (11.59 in)	53.6 (2.11 in)
CD 90	28~37 kg/0.5 m/sec (61.6~81.4 lbs/19.7 in/sec)	"	Max 251.5 ( 9.91 in) Min 190.3 ( 7.50 in)	61.2 (2.41 in)
C 90	25~31 kg/0.5 m/sec (55~68 lbs/20 in/sec)	"	Max 323.4 (12.73 in) Min 261 (10.28 in)	62.4 (2.46 in)
CT 90	40~50 kg/0.5 m/sec (88~110 lbs/20 in/sec)	"	Max 323.4 (12.73 in) Min 261 (10.28 in)	62.4 (2.49 in)
CT 90 (from frame No.000001A)	40~50 kg/0.5 m/sec (88~110 lbs/20 in/sec)	"	Max 336.5 (13.3 in) Min 261 (10.28 in)	77.5 (3.05 in)

### 2. Rear cushion spring

	Item	Standard value	Serviceable limit
S 90	Free length	171.6 (6.761 in)	Replace if under 155.8 (6.139 in)
	Load	101.1 mm/117 kg (3.983 in/257.4 lbs)	—
	Tilt	Within 1.5°	Replace if over 2°
CL 90 CL 90 L	Free length	172.4 (6.7874 in)	Replace if under 157.5 (6.21 in)
	Load	118 mm/103.4 ~116.6 kg (4.6457 in/2.280 ~2.571 lbs)	—
	Tilt	Within 1.5°	Replace if over 2°
CD 90	Free length	211 (8.313 in)	Replace if under 190 (7.48 in)
	Load	140.4 mm/100 kg (5.532 in/220.0 lbs)	—
	Tilt	Within 1.5°	Replace if over 2°
C 90	Free length	212 (8.313 in)	Replace if under 190 (7.48 in)
	Load	141.5 mm/120 kg (5.57 in/264 lbs)	—
	Tilt	Within 1.5°	Replace if over 2°
CT 90	Free length	222.9 (8.776 in)	Replace if under 207 (8.16 in)
	Load	142.7 mm/157.5 kg (5.6181 in/3.473 lbs)	—
	Tilt	Within 1.5°	Replace if over 2°

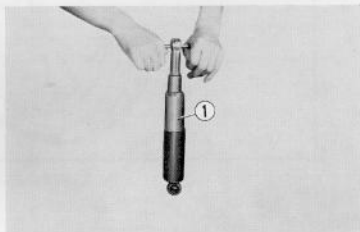

Fig. 4.80 Manual operation of rear cushion  
① Rear cushion

## 4.12 FRONT WHEEL

## A. Construction

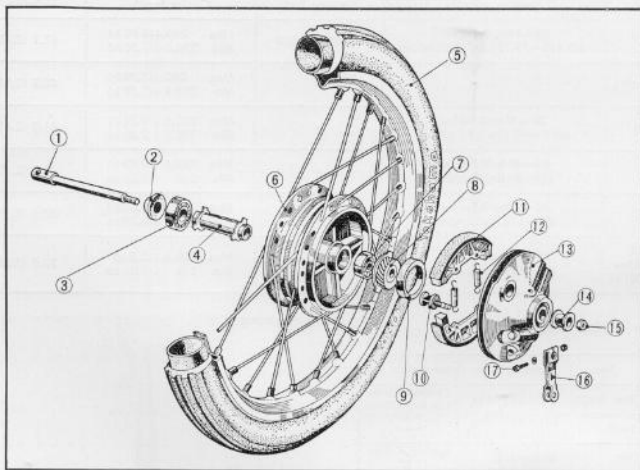

Fig. 4.81 Component parts of front wheel

- |                       |                           |
|-----------------------|---------------------------|
| ① Front wheel axle    | ⑩ Front brake cam         |
| ② 17377 oil seal      | ⑪ Brake shoe              |
| ③ 6301 R ball bearing | ⑫ Brake shoe spring       |
| ④ Distance collar     | ⑬ Front brake panel       |
| ⑤ Front wheel tire    | ⑭ Front wheel side collar |
| ⑥ Front wheel hub     | ⑮ Axle nut                |
| ⑦ 6301 R ball bearing | ⑯ Front brake arm         |
| ⑧ Speedometer gear    | ⑰ 6×25 hex bolt           |
| ⑨ 47587 oil seal      |                           |

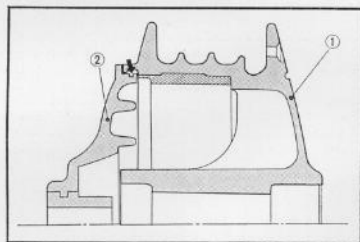

Fig. 4.82 Protective covering

- |               |
|---------------|
| ① Wheel hub   |
| ② Brake panel |

The front wheel axle and the axle nut assembles the aluminum alloy hub, front brake panel consisting of the brake shoes, two ball bearings and a speedometer gear. (Fig. 4.81)

The reaction force created by braking is transmitted from the brake panel direct to the front fork.

For the CD 90, C 90, CT 90, the force is transmitted to the front fork by means of the torque link. Further, to provide waterproofing and dust proofing features to the front wheel hub and brake panel, a labyrinth has been designed into the hub. (Fig. 4.82)

**B. Disassembly****(S 90, CL 90, CL 90 L)**

1. Place a support block under the engine.
2. Remove the front brake adjusting nut ① and disengage the brake cable ② from the front brake arm. (Fig. 4.83)
3. Disconnect the speedometer cable ③ from the front brake panel. (Fig. 4.83)
4. Remove the front wheel axle nut and draw out the axle.
5. The wheel will drop away from the front fork.

**(CD 90, C 90, CT 90)**

- (1) Place a support block under the engine.
- (2) Remove the front brake adjusting nut and disengage the brake cable ② from the front brake arm.
- (3) Disconnect the speedometer cable ① from the brake panel.
- (4) Remove the castle nut ④ and pull out the panel stopper bolt ⑤.
- (5) Loosen the two 8 mm bolts ⑥ at the front suspension arms.
- (6) Remove the front axle nut and pull out the axle ③, the front wheel will drop away from the front fork.

**(all model)**

6. Separate the front brake panel ② from the front wheel hub ①, remove the speedometer gear and disassemble the brake arm from the panel. (Fig. 4.85)
7. The brake shoes are held in place by springs ①, therefore, spread the shoes apart to disassemble from the brake panel. (Fig. 4.86)
8. Disassemble the brake cam from the front brake panel.
9. Remove the oil seal from the front brake panel.
10. Remove the side collar and the oil seal from the front wheel hub.
11. Remove the ball bearing and the axle distance collar from the front hub.
12. Remove the tire ① from the rim with the tire lever ② and pull out the tube from the casing. (Fig. 4.87)

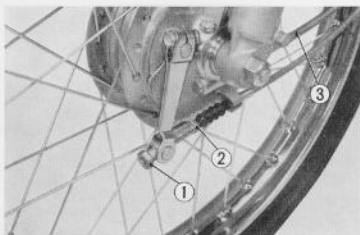

**Fig. 4.83** Removing cables  
 ① Front brake adjusting nut  
 ② Front brake cable  
 ③ Speedometer cable

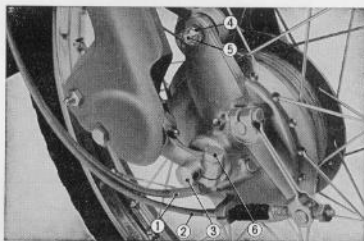

**Fig. 4.84** Removing front wheel  
 ① Speedometer cable  
 ② Brake cable  
 ③ Front axle  
 ④ Castle nut  
 ⑤ Panel stopper bolt  
 ⑥ 8 mm hex bolt

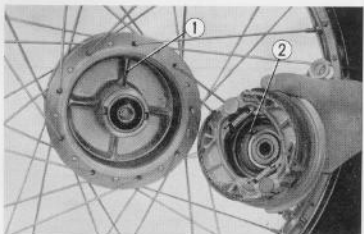

**Fig. 4.85** Separate brake panel  
 ① Front wheel hub  
 ② Front brake panel

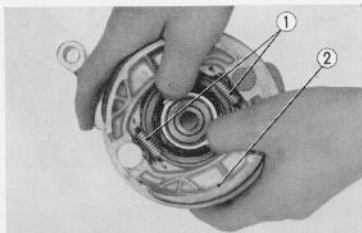

Fig. 4.86 Disassembling brake shoes  
① Brake shoe spring ② Brake shoe

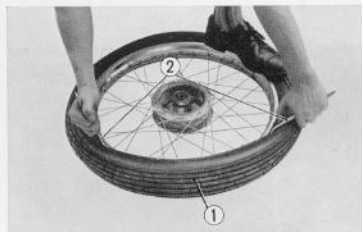

Fig. 4.87 Removing tire ① Tire ② Tire lever

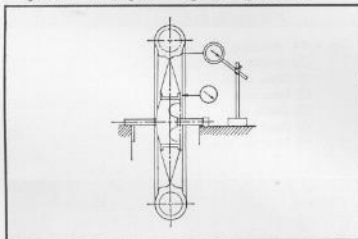

Fig. 4.88 Measuring wheel runout

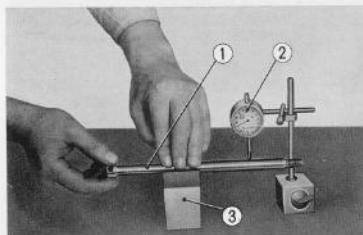

Fig. 4.89 Measuring bend of axle  
① Front axle ② Dial gauge  
③ V block measuring bend at axle

### C. Inspection

1. Check the rim for both vertical and side runout.

Item	Standard value	Serviceable limit
Side runout	0.7~1.0 (0.028~0.040 in)	Repair if over 1.0 (0.040 in)
Vertical runout	0.5 max (0.020 in)	Repair if over 1.0 (0.040 in)

2. Check the front axle for wear and bend. (Fig. 4.89)

Item	Standard value	Serviceable limit
Diameter	9.995~10.050 (0.394~0.396 in)	---
Bend	0.2 (0.008 in)	Repair or replace if over 0.5 (0.020 in)

3. Check brake shoe spring.

Item	Standard value	Serviceable limit
Free length	28.7 (1.131 in)	Replace if over 33.0 (1.3 in)

4. Check the brake shoes. (Fig. 4.90)

Item	Standard value	Serviceable limit
Outside diameter	109.2~109.5 (4.2992~ 4.3110 in)	Replace if under 107.5 (4.2323 in)
Lining thickness	4 (0.1575 in)	Replace if under 3 (0.1181 in)

5. Check the thickness of the front brake cam.  
Standard value : 6 mm (0.236 in)  
Serviceable limits : Replace if excessively worn, deformed or damaged.
6. Check the spokes for tightness.  
Retorque any spokes found loose, 4~21 kg·cm (0.3~1.5 ft. lbs.)
7. Inspect the tube for leaks by inflating, submerge in water, and check for bubbles.
8. Inspect the tire both on the inside as well as the outside for damages and imbedded nails.



### D. Reassembly

1. Install the rim band so that it will completely cover the spoke nipples. (refer to rear wheel reassembly)
2. Assemble the tube between the rim and tire, inflate the tube with a small amount of air and force the tire bead into the rim.

#### NOTE:

- a. After the tire is assembled on the rim, inflate the tire to 1/3 the normal pressure  $1.6 \sim 1.8 \text{ kg/cm}^2$  ( $22.8 \sim 25.6 \text{ lbs/in}^2$ ) and then tap the tire lightly over the entire circumference to relieve any pinching of the tube. (Fig. 4.91)
  - b. The valve stem must be pointed radially toward the center of the wheel. (Fig. 4.92)
3. Remove old grease from wheel hub and bearing, and repack with new grease. Install the distance collar and drive in the bearing.
  4. Apply grease to the shaft of the brake cam and assemble into the brake panel. Assemble both brake shoes and install the brake springs.
  5. Assemble the speedometer gear into the front brake panel. Install the distance collar and the brake panel on the hub, followed by inserting the axle through the hub and torque with the axle nut.
  6. Install the speedometer cable to the front brake panel.
  7. Assemble the front brake arm to the brake cam shaft, connect the brake cable to the brake arm and adjust the play of the brake lever with the adjuster nut.

(CD 90, C 90, CT 90)

- (1) Assemble the speedometer gear into the front brake panel. Install the distance collar and the brake panel on the hub, followed by inserting the axle through the hub.
- (2) Connect the front wheel panel to the brake torque link with a stopper bolt.
- (3) Tighten the axle nut and 8 mm hex bolts on the suspension arms.
- (4) Connect the brake cable to the brake arm and adjust the play with the adjuster nut.

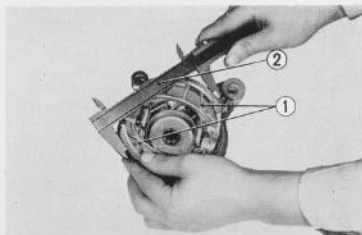

Fig. 4.90 Measuring brake lining  
① Brake shoe  
② Vernier caliper

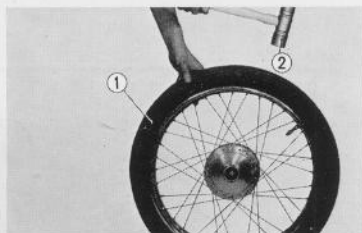

Fig. 4.91 Seating tube  
① Front tire  
② Plastic hammer

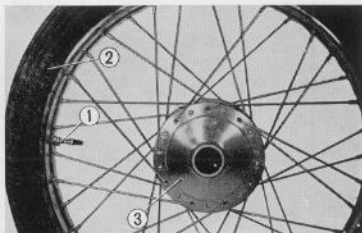

Fig. 4.92 Valve in line  
① Valve stem  
② Front tire  
③ Front wheel hub

## 4.13 REAR WHEEL

## A. Construction

The rear wheel is constructed similar to the front wheel with ball bearings, cast aluminum wheel hub and brake panel.

The rear brake panel is assembled on the right side which includes the brake shoes and brake cam.

On the left side, the final driven flange and final driven sprocket are assembled with the driven sprocket setting bolts and this unit is installed on the rear fork by the rear axle through the side collar. The rear brake panel and wheel hub is equipped with a labyrinth to provide dust and waterproofing. (Fig. 4.93)

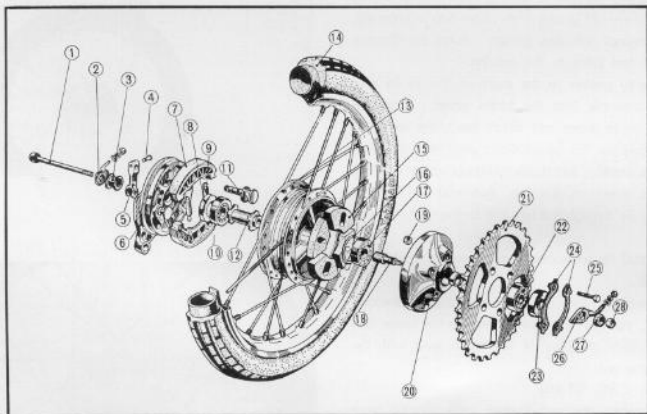

Fig. 4.93 Component parts of rear wheel

- |                                |                                |
|--------------------------------|--------------------------------|
| ① Rear wheel axle              | ⑮ Rear wheel damper            |
| ② Right drive chain adjuster   | ⑯ 40.5 × 3 O ring              |
| ③ Rear brake panel side collar | ⑰ 6301 ball bearing            |
| ④ 6 × 22 hex bolt              | ⑱ Rear axle sleeve             |
| ⑤ Rear brake arm               | ⑲ 8 mm thin nut                |
| ⑥ Rear brake panel             | ⑳ Final driven flange          |
| ⑦ Brake shoe                   | ㉑ Final driven sprocket        |
| ⑧ 18377 oil seal               | ㉒ 6203 Z ball bearing          |
| ⑨ Brake shoe spring            | ㉓ 23406 oil seal               |
| ⑩ 6301 ball bearing            | ㉔ 8 mm tongue and washer       |
| ⑪ Rear brake cam               | ㉕ Driven sprocket setting bolt |
| ⑫ Rear axle distance collar    | ㉖ Left drive chain adjuster    |
| ⑬ Rear wheel hub               | ㉗ Rear axle sleeve nut         |
| ⑭ Rear wheel tire              | ㉘ axle nut                     |

## B. Disassembly

1. Remove the left crankcase rear cover, disconnect the drive chain. ①. (Fig. 4.94)
2. Unscrew the 6 × 10 mm hex bolts and remove the chain case.
3. Remove the muffler.
4. Remove the rear brake torque link bolt and separate the torque link from the brake panel.
5. Unscrew the rear brake adjusting nut and disconnect the rear brake rod from the brake arm.
6. Unscrew the rear axle nut and draw out the axle to remove the chain adjuster and the side collar together.
7. Remove the rear wheel. (Fig. 4.95)
8. Remove the rear axle sleeve nut and then remove the final driven sprocket and final driven flange as a complete unit.
9. Draw out the rear axle sleeve from the final driven flange, unlock the 8 mm tongued washer ① and remove the driven sprocket setting bolt ②. Disassemble the final driven sprocket ③ and final drive flange ④. (Fig. 4.96)



Fig. 4.94 Disconnecting drive chain  
① Drive chain

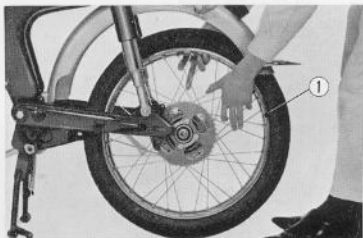

Fig. 4.95 Removing rear wheel  
① Rear wheel.

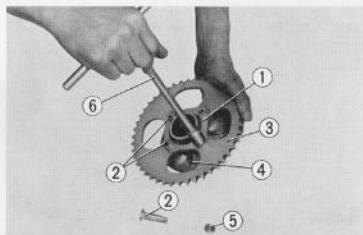

Fig. 4.96 Removing sprocket  
① 8 mm tongued washer  
② Setting bolt  
③ Final driven sprocket  
④ Final driven flange  
⑤ 8 mm nut  
⑥ 14 mm T-handle wrench

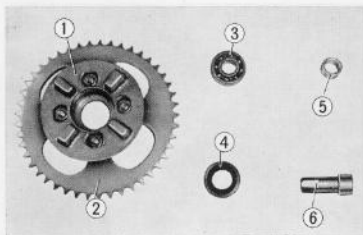

Fig. 4.97 Component parts of final driven flange

- ① Final driven flange
- ② Final driven sprocket
- ③ 6203 Z ball bearing
- ④ Oil seal
- ⑤ Rear axle sleeve collar
- ⑥ Rear axle sleeve

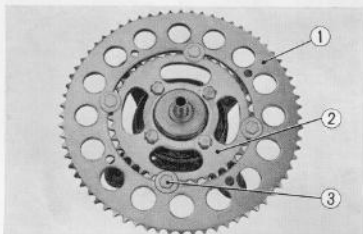

Fig. 4.98 Removing final driven sprocket

- ① Final driven sprocket B
- ② Final driven sprocket A
- ③ Sprocket setting bolt

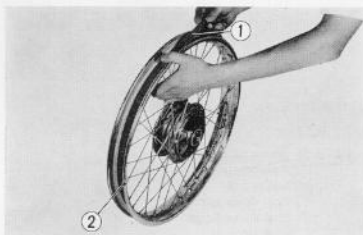

Fig. 4.99 Installing rim band

- ① Rim band
- ② Rear wheel rim

10. Remove the rear axle sleeve collar from the final driven flange, oil seal (oil seal No. 23406 used on frame Nos. S90-111565~S90-142498 and S90-424487~S90-493162 and subsequent, and oil seal No. 27406 used on frame No. S90-493162, frame No. S90-542753 A and subsequent.), ball bearing 6203 Z. (Fig. 4.97)

(CT 90) On frame number prior to CT 90-122550, the final driven sprocket A, B, are mounted on the final driven flange. Remove the four mounting bolts to disassemble the final driven sprocket B from sprocket A. (Fig. 4.98)

The sub-transmission replaced the double sprocket for changing the speed range, from Frame No. CT 90-122551.

11. Remove the 40.5×3 "O" ring from the rear wheel hub, rear wheel damper, 6301 ball bearing, 18377 oil seal and rear axle distance collar to remove the rear wheel.
12. Remove the brake shoe from the rear brake panel by expanding the shoe retaining spring. Remove the brake cam from the brake panel.
13. Disassemble the tire and tube from the rim by using the tire lever.

#### C. Inspection

1. Check the rim for both vertical and side runout.

Item	Standard value	Serviceable limit
Side runout	0.7~1.0 (0.028~0.040 in)	Repair if over 1.0 (0.040 in)
Vertical runout	0.5max (0.020 in)	Repair if over 1.0 (0.040 in)

2. Check the rear axle for wear and bend.

Item	Standard value	Serviceable limit
Diameter	11.984~12.957 (0.472~0.515 in)	—
Bend	0.2 (0.00 in)	Repair or replace if over 0.5 (0.020 in)

## 3. Check brake shoe spring.

Item	Standard value	Serviceable limit
Free length	28.7 (1.130 in)	Replace if over 3.30 (1.2992 in)
Tension	39.0mm/11.4kg (1.535 in~25.137 lb)	—

## 4. Check the brake shoes.

Item	Standard value	Serviceable limit
Outside diameter	109.2~109.5 (4.2990~4.31 in)	Replace if under 107.5 (4.2323 in)
Lining thickness	4 (0.5575 in)	3 (0.1181 in)

## 5. Check the thickness of the rear brake cam.

Standard value : 6 mm (0.236 in)

Serviceable limit : Replace if excessively worn, deformed or damaged.

## 6. Check the spokes for tightness. 8~25 kg·cm (0.6~1.8 ft·lbs)

Retorque any spoke found loose.

## 7. Inspect the tube for leaks by inflating, submerge in water and check for bubbles.

## 8. Inspect the tire both on the inside as well as the outside for damages and imbedded nails.

## D. Reassembly

1. Install the rim band ① so that it completely covers the spoke nipple. (Fig. 4.99)

2. Assemble the tube and tire ③ to the rim ① by inflating the tube slightly so that it holds the shape, place inside the tire and then install the tire on the rim. (Fig. 4.100)

## CAUTION

a. After the tire has been installed on the rim, inflate to approximately 1/3 normal pressure (1.8~2.0 kg/cm<sup>2</sup> ; 25.6~28.5 lbs/in<sup>2</sup>) and then lightly tap the tire all the way around with a mallet to correct any portion of the tube which may be pinched.

b. The tube valve stem must be pointed radially inward toward the axle, otherwise, air leak may develop.

3. Drive the ball bearing into the final driven flange, and install the oil seal and the rear axle sleeve collar. (Fig. 4.101)

4. Assemble the final driven sprocket to the final driven flange (assemble final driven flange A and B on CT90 F.No. 122550 and earlier) and in-



Fig. 4.100 Assembling tire

- ① Rear wheel rim
- ② Tire lever
- ③ Rear wheel tire

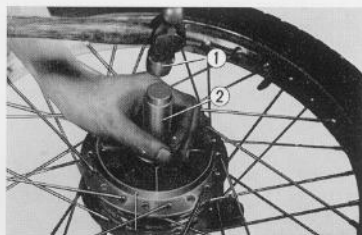

Fig. 4.101 Replacing ball bearing

- ① Hammer
- ② Bearing driver

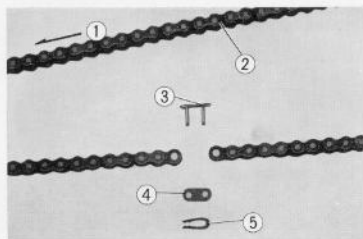

Fig. 4.102 Chain clip direction

- ① Rotation direction
- ② Drive chain
- ③ Chain joint
- ④ Chain joint ring plate
- ⑤ Chain joint clip

sert the final driven flange through the rear axle sleeve.

5. Assemble the brake panel to the wheel hub. Install the rear wheel to the rear fork by assembling the chain adjuster, brake panel side collar; insert the axle through the rear fork and wheel hub.
6. Assemble the chain over both sprockets and joint the ends with the joint clip followed by adjusting the tension and torquing the axle nut.

#### CAUTION

- a. The chain joint clip must be installed so that the opening is opposite to the direction of rotation. (Fig. 4.102)
  - b. The chain tension must be made so that the right and left chain adjuster is in the same location relative to the rear fork. This can be checked by the alignments marks on both the adjusters and the fork.
7. Install the rear brake torque link to the rear brake panel.
  8. Connect the brake rod to the rear brake arm and make the adjustment with the adjusting nut so that the free play at the brake pedal is 2~3 cm (0.80~1.2 in).
  9. Install the chain case.
  10. Install the muffler.
  11. Inflate the tires to the proper pressure.

## 5. PERIODIC ADJUSTMENT

### 5.1 MAINTENANCE INSPECTION

Effort should be made to educate the users to have their motorcycles inspected at the regular inspection schedules and designated mileages. They should be made aware that by receiving proper maintenance, trouble free operation is assured, further, the warranty is effective only when regular maintenance has been performed.

#### A. Engine Adjustment

##### 1. Measuring cylinder compression

A low compression pressure will result in a corresponding drop in the engine power output. Further, pressure leak from any cause can effect the engine speed adjustment at low speed and result in engine stall.

- Remove the spark plug.
- Insert the end of the compression gauge into the spark plug hole and hold firmly to prevent pressure from leaking. (Fig. 5.1)
- Operate the kick starter, repeatedly several times with both the choke and throttle in the full open positions.

#### NOTE:

- Make sure that the throttle and choke are fully opened, or else, a lower pressure indication will be registered on the compression gauge.
  - The cylinder compression pressure indication will gradually increase with each kick, therefore, continue kicking until the pressure stabilizes at the highest point and then take the reading.
  - To obtain a true cylinder pressure indication, the measurement should be made after the engine attains operating temperature.
  - Check for the proper operation of the valves.
  - Make sure that the compression gauge is firmly fitted in the spark plug hole.
- d. The standard specified cylinder compression pressure is  $12 \text{ kg/cm}^2$  ( $171 \text{ lb/in}^2$ ).

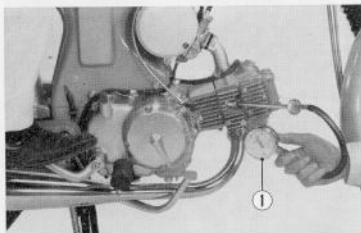

Fig. 5.1 Measuring compression pressure  
① Compression gauge

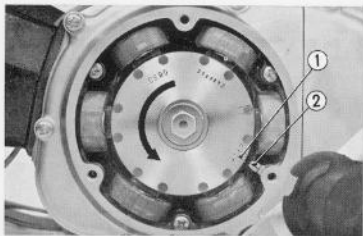

Fig. 5.2 Aligning to the "T" timing mark

- ① "T" mark
- ② Alignment mark

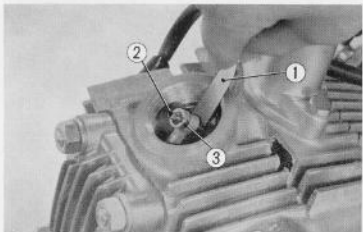

Fig. 5.3 Adjusting tappet clearance

- ① Thickness gauge: 0.05 mm (0.002 in)
- ② Adjusting screw
- ③ Adjust locking nut

- e. In case the compression pressure exceeds 14 kg/cm<sup>2</sup> (199 lb/in<sup>2</sup>), it is an indication of heavy carbon deposit accumulation on the cylinder head or the piston. The deposits should be removed by disassembling the cylinder head from the cylinder.
- f. When the compression pressure registers less than 10 kg/cm<sup>2</sup> (142 lb/in<sup>2</sup>), it is an indication of pressure leak. First, check the tappet adjustment and see if the condition can be corrected, if not, disassemble the engine and inspect the condition of the valves, the cylinder head gasket and piston rings.

## 2. Tappet adjustment

The tappet clearance will have a great deal of effect on the valve timing. If the clearance is too small, it may prevent the valve from fully closing, and result in pressure leak at the valve. On the other hand, an excessive tappet clearance will produce tappet noise and result in noisy engine operation. Tappet clearance will have a varying degree of effect on the engine power output as well as engine operation at slow speed.

### 1. Valve clearance

- a. Remove the left crankcase cover and align the timing mark "T" ① on the flywheel with the alignment mark ② on the stator. (Fig. 5.2)
- b. Remove the tappet adjusting caps on the cylinder head and check the clearance between the adjusting screw and the valve. (Fig. 5.3)

If the valve is actuated by the rocker arm and is in the open position, rotate the flywheel one complete revolution to set the piston at top-dead-center of the compression stroke, and then perform the check.

### 2. Adjustment

Loosen the adjusting screw locking nut ③ and make the adjustment with the adjusting screw ② to obtain the standard clearance of 0.05 mm (0.002 in) for both the inlet and exhaust valves.

Turn screw clockwise to obtain closer clearance.

Turn screw counter-clockwise for wider clearance.

The tappet clearance adjustment for all valves are identical.



**NOTE:**

1. The adjustment must be made with a cold engine. Clearance is measured with a 0.05 mm (0.002 in) thickness gauge.
2. When locking the adjusting screw, hold the screw while locking the nut to prevent its turning. (Fig. 5.4)
3. Inspection
  - a. Check to make sure that the tappet clearance is within standard tolerance. Too small a clearance will cause the valve to stay open, causing pressure leakage and resulting in hard starting or no starting at all.
  - b. Check for improper valve timing.
  - c. Check for stretch in the cam chain.
  - d. Check for any slippage of the timing sprocket.

**3 Breaker point servicing and gap adjustment**

- a. Remove the dynamo cover and breaker point cover.

Inspect the surfaces of the breaker points; if they are burnt or pitted, dress the surface with an oilstone or a point dressing file so that the points are making parallel contact.

After the points have been dressed, wash in gasoline or trichloroethylene to remove all trace of oil.

- b. Turn the generator rotor counter-clockwise to the point where the breaker points are at maximum opening. The normal gap ① is 0.3 to 0.4mm (0.012~0.016 in). If adjustment is necessary, loosen the two breaker arm adjusting screws ② and move the stationary breaker point by inserting a screwdriver into the adjusting slot to obtain the proper gap and then retighten the screws. (Fig. 5.5)

**Insufficient breaker point gap:**

- (a) The spark tend to linger, that is the interruption of the primary circuit is not completed at the points, therefore, the secondary high voltage build-up is reduced.
- (b) The closed duration of the points is longer, producing heat and resulting in damage.
- (c) In conjunction with (b) above, the points will be late in opening causing a delay in the ignition timing; this will cause a drop in power output.

**Excessive breaker point gap:**

- (a) The duration that the points are closed is too short to allow for sufficient current flow in the primary circuit with a consequent low voltage

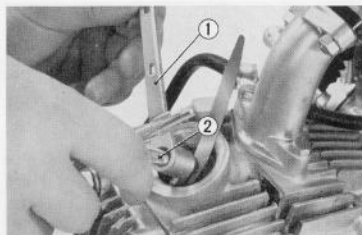

Fig. 5.4 Locking the adjusting nut

- ① 9 mm wrench
- ② 3 mm wrench

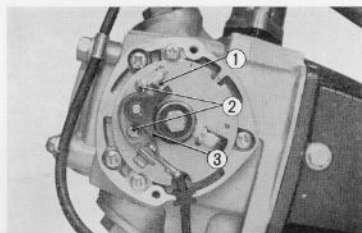

Fig. 5.5 Adjusting the point clearance

- ① Contact breaker points
- ② Breaker arm adjusting screw
- ③ Breaker arm

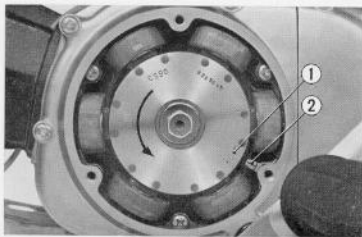

Fig. 5.6 Adjusting the ignition timing

- ① "F" mark
- ② Alignment mark

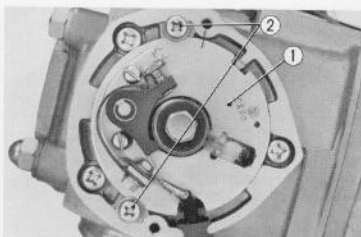

Fig. 5.7 Adjusting the ignition timing

- ① Base plate
- ② Base plate screws

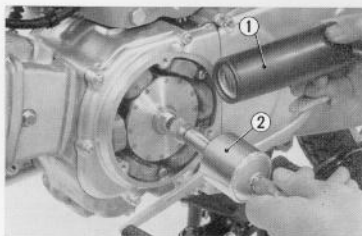

Fig. 5.8 Adjusting the ignition timing advance

- ① Timing light
- ② Tachometer

build-up in the secondary or the high tension voltage circuit. This condition will cause poor engine starting, spark missing at high speed and a consequent loss of power.

- (b) Engine over-heats readily.
- (c) The ignition timing is greatly advanced.

#### 4. Ignition timing adjustment

- a. Whenever the breaker point gap has been adjusted, the ignition timing will be affected and therefore it must also be readjusted.
- b. With the dynamo cover removed, rotate the generator rotor counter-clockwise until the "F" mark ① on the flywheel lines up with the alignment mark ② on the stator. (Fig. 5.6) In this position, the breaker point should just commence to open. This can be checked with a thin thickness gauge. If adjustment is necessary, loosen the base plate screws ② and rotate the base plate ① by inserting a screwdriver into the adjusting slot to obtain the proper timing. (Fig. 5.7)
- c. The static ignition timing is relatively accurate and will give satisfactory engine performance, however, the use of the service tester will assure the most precise timing. (refer to service tester operation).

When using a strobo timing light ① to check the timing, idle the engine at 1,200 r.p.m. (Fig. 5.8) If it is found out of timing, perform the adjustment in the same manner as described above.

Results of retarded ignition timing :

1. Drop in power output.
2. Drastic increase in fuel consumption.
3. Engine overheats with a possibility of piston seizure.

Results of advanced ignition timing :

1. Produces knocking and drop in power output. In severe cases, damage to piston, connecting rod, crankshaft may result, therefore, periodic inspection should be performed.
2. Upon completion of the point gap and ignition timing adjustment, check for proper operation of the spark advancer with the service tester.

### 5. Spark plug adjustment

A dirty or damaged spark plug, or plug electrodes which are eroded will not produce a good strong spark, therefore, the spark plugs should be inspected periodically and cleaning and adjustments made. Spark plugs with sooty, wet electrodes, or electrodes covered with deposits will permit the high tension voltage to bypass the gap without sparking.

#### 1. Cleaning

a. The use of the spark plug cleaner is the recommended method of cleaning the plugs, however, a satisfactory cleaning can be performed by using a needle or a stiff wire to remove the deposits and then wash in gasoline followed by drying with compressed air. (Fig. 5.9)

b. Adjust the spark gap after cleaning.

Set the gap to 0.6~0.7 mm (0.024~0.028 in) by bending the electrode on the ground side. (Fig. 5.10)

#### 2. Spark Plug Inspection

a. Check the spark intensity produced between the gap of the ground and the center electrodes.

Blue spark ..... Good condition

Red spark ..... Poor condition

Cause due to:

1. Low supply voltage
2. Defective ignition coil
3. Defective spark plug
4. No sparking may also be due to compression

#### CAUTION:

1. Do not remove the deposits by burning.
2. When installing the spark plugs, clean the seating area free of oil or foreign matter and install finger tight before torquing with a plug wrench.
3. The spark plugs can be tested after adjustment, with the plug tester. With the high tension voltage maintained constant, vary the test chamber pressure and inspect the condition of the spark.



Fig. 5.9 Spark plug cleaner  
① Spark plug  
② Spark plug cleaner



Fig. 5.10 Measuring spark gap

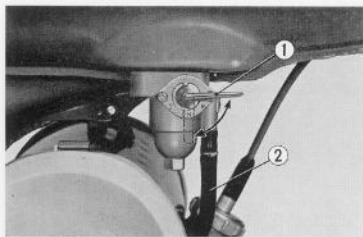

Fig. 5.11 Fuel cock lever

- ① Fuel cock lever
- ② Fuel feed tube

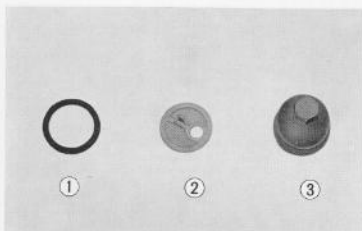

Fig. 5.12 A Cleaning fuel strainer IS 90, CL 90, CL 90L, CD 90

- ① "O" ring
- ② Screen
- ③ Fuel strainer cup

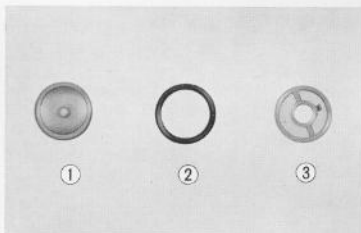

Fig. 5.12 B Cleaning fuel strainer IC 90, CT 90

- ① Fuel strainer cup
- ② "O" ring
- ③ Screen

## 6. Fuel supply system

Restriction in the fuel supply system will prevent sufficient fuel flow to the carburetor and cause engine to sputter during acceleration or the engine may stall at high speed.

- a. Check for sufficient supply of fuel in the tank.
- b. Disconnect the fuel feed tube ② from the carburetor and check the fuel flow with the fuel cock ① in the ON or the R position. (Fig. 5.11)
- c. If the fuel flow is insufficient, remove the fuel cock, disassemble and clean. When the flow is still inadequate, remove the fuel tank from the frame body and clean internally.

### CAUTION:

- ① The insufficient fuel flow may be caused by the plugged vent hole in the filler cap as well as the restriction in the fuel line.
- ② The fuel cock is switched to R (reserve) from the ON position when the fuel tank becomes empty.

## 7. Fuel strainer cleaning

The foreign substances contained in the fuel passes through the fuel line from the fuel tank and enters the strainer cup. The foreign substances and water, if not arrested, will enter the cylinder and causes engine failure.

### 1. Cleaning

- a. Set the fuel cock lever to the S position.
- b. Remove the strainer cup and filter screen.
- c. Clean the strainer cup and filter screen. (Fig. 5.12)

### NOTE:

C 90, CT 90: The fuel strainer is incorporated the rear end of the carburetor.

## 8. Oil filter screen cleaning

The engine oil is filtered through a system of double filters before it is supplied to the various parts of the engine. When impurities have accumulated in the filters to prevent its proper function, the oil supply to the various parts are starved and eventually result in seizure and damage to the engine. It is therefore important that the filters be cleaned periodically.

## 1. Cleaning

- a. Remove the kick starter pedal.
- b. Remove the right crankcase cover, pull out the oil screen and wash in gasoline. (Fig. 5.13)

**CAUTION:**

Install the oil filter screen with the narrow tapered side toward the inside and the fin on the filter screen toward the bottom.

## 9. Air cleaner servicing

An air cleaner clogged with dust restricts the free passage of inlet air and result in power loss or drop in acceleration, therefore, to assure proper performance, periodic cleaning of the air cleaner should be performed.

## 1. Removal. (Fig. 5.14)

Refer to page 98~99.

## 2. Cleaning

- a. Tap the cleaner element lightly to loosen the dust and then blow dry compressed air from the inside or use a brush to remove the dust. (Fig. 5.15)

**CAUTION:**

1. Air cleaner element is made of cellulose acetate and if distorted or damaged, it will permit dusts to enter engine cylinder and cause excessive cylinder wear.
2. Oil or water will cause the element to become clogged and will result in lowered engine performance.

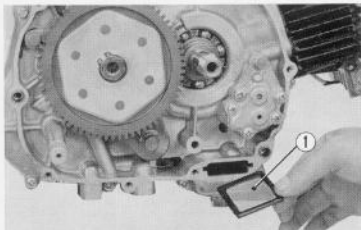

Fig. 5.13 Removing oil filter screen ① Oil filter screen

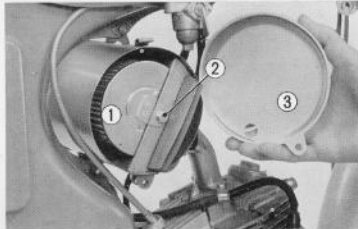

Fig. 5.14 Removing air cleaner  
① Air cleaner ② 6 mm bolt ③ Air cleaner cover

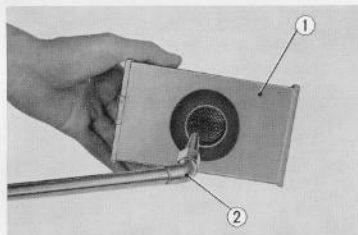

Fig. 5.15 Cleaning air cleaner element  
① Air cleaner ② Air gun

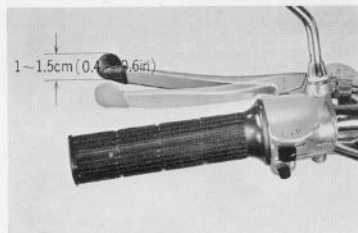

Fig. 5.16 Free play of clutch lever

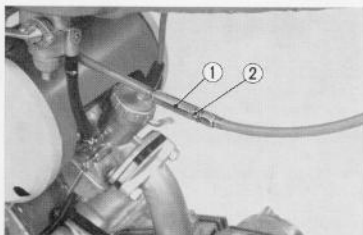

Fig. 5.17 Adjusting clutch cable  
 ① Clutch cable adjuster  
 ② Lock nut

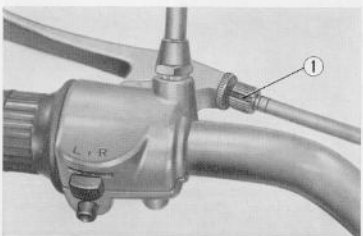

Fig. 5.18 Adjusting clutch cable  
 ① Clutch cable upper adjuster

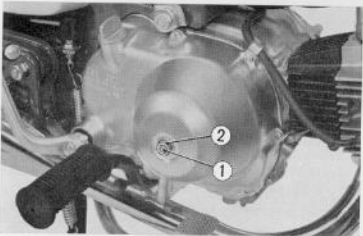

Fig. 5.19 Adjusting the clutch  
 ① Clutch adjusting screw  
 ② Lock nut

## 10. Clutch adjustment

The function of the clutch is to transmit or disengage the rotary power produced by the engine to the transmission. If the gear is engaged without the clutch being completely disengaged, the motorcycle will start moving with a jolt or the engine will stall out.

On the other hand, if the clutch is slipping, the speed of the motorcycle will "lag" in relation to the engine speed.

### 1. Lever play

There should be 1 to 1.5 cm (0.4~0.6 in) of free play in the clutch lever before the clutch starts to disengage. (S 90, CL 90, CL 90 L, CD 90) (Fig. 5.16)

### 2. Adjustment

(S 90, CL 90, CL 90 L, CD 90)

The clutch lever play can be adjusted at the lever by loosening the lock nut and screwing the adjuster bolt in or out. On some models, there is also a provision to perform the adjustment at the adjuster coupling located midpoint on the clutch cable.

The proper clutch lever free travel should be approximately 1~1.5 cm (0.4~0.6 in) when measured at the end of the lever. (Fig. 5.17, 18)

(C 90 and CT 90)

The C 90 and CT 90 are equipped with an automatic clutch and, therefore, does not have a clutch lever.

The clutch adjustment is made at the clutch adjusting screw. ① (Fig. 5.19)

1. Loosen the lock nut ② and turn the adjusting screw ① to the left, using a screwdriver, until the turning becomes hard and then turn in the opposite direction about  $\frac{1}{8}$  turn and tighten the lock nut. This should provide the proper automatic operation. (Fig. 5.19)
2. By turning adjusting screw to right, the clutch disengagement will be slowed and to left it will be quickened.

### Inspection

(S 90, CL 90, CL 90 L, CD 90)

1. Kick start the engine and shift into low gear, shifting should be smooth without any jolt or engine stall when the gear is engaged.
2. The motorcycle should move smoothly as the clutch lever is gradually released.

**(C 90, CT 90)**

1. When the transmission is shifted to low gear while the engine is idling, the engine should not stall or jolt.
2. As the throttle is opened, the motorcycle should start to move gradually.

**11. Carburetor cleaning and adjustment**

A dirty carburetor or carburetor out of adjustment will cause poor engine performance. As an example, a carburetor set to a lean fuel air mixture will cause the engine to overheat while a rich mixture will cause engine to run sluggish. An over flowing of fuel from the carburetor is a possible fire hazard, therefore, periodic cleaning and adjustment should be performed.

**1. Cleaning**

- a. Disassemble the carburetor and wash the parts in gasoline.
- b. Blow out the nozzles with compressed air and after cleaning and reassembly, make the adjustment.

**2. Idle adjustment**

The idle adjustment is performed with both the throttle stop screw and the air screw by the following procedure. (Fig. 5.20)

- a. Set the throttle stop screw to the specified idling speed. (Fig. 5.21)

- b. Next, adjust the air screw by turning slowly in both direction to obtain the highest engine speed.

Turning the screw in will produce a rich fuel mixture.

Turning the screw out will produce a lean fuel mixture.

- c. Reduce the engine speed which has gone up in (b) to the specified RPM by regulating the throttle stop screw.
- d. At this throttle stop screw setting, recheck the carburetor adjustment by manipulating the air screw.
- e. After the idling adjustment has been completed, check the carburetor by snapping the throttle and also check the throttle response. The air screw should be set to  $\frac{1}{8}$  turn of the specified setting. (Refer to page 73)

**NOTE:** All adjustment should be made after the engine has attained operating temperature.

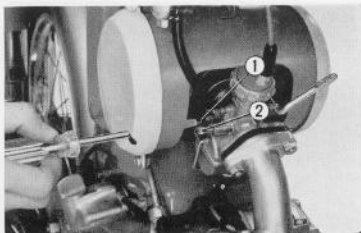

Fig. 5.20 Adjusting the carburetor

- ① Throttle stop screw
- ② Air screw

MODEL	IDLING SPEED (R.P.M.)
S 90	1,250~1,350
CL 90, CL 90 L	"
CD 90	"
C 90	1,400~1,600
CT 90	"

Fig. 5.21 Idling speed setting table



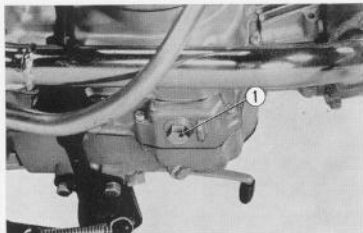

Fig. 5.22 Removing drain bolt  
① Drain plug

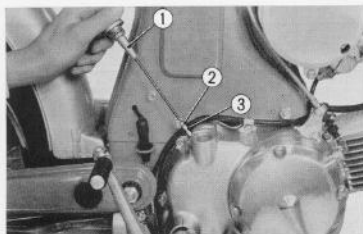

Fig. 5.23 Oil level gauge  
① Oil level gauge  
② Upper level mark  
③ Lower level mark

SAE GROUPS	OUTSIDE TEMPERATURE	SAE GROUPS
# 30		# 10W-30
# 20or		
# 20W		
# 10W		

Fig. 5.24 Specified oil grade

## B. Lubricating

The purpose of lubrication is to prevent direct surface to surface contact of the moving parts by providing a film of oil between the surfaces and thereby, reducing friction and preventing wear. It also serves to cool the parts from the heat produced by friction.

Further, the lubricant penetrates between the piston and cylinder to form an oil film which act as a seal to prevent loss of the cylinder pressure.

### 1. Parts not requiring periodic oil change or lubrication

There are some parts which only require lubrication whenever the parts are disassembled for repair or replacement. There are:

- Steering stem steel balls and cone race
- Throttle grip
- Main stand

### 2. Engine oil change

Change oil at 1,500 km (1,000 mile) driving.

#### 1. Oil change

- a. Remove the oil cap and drain the engine completely of oil by unscrewing the drain plug ① at the bottom of the engine. (Fig. 5.22)

**NOTE:** The oil should be drained while the engine is still warm.

- b. The proper oil level is indicated by the oil between the level markers on the gauge when checked without screwing the cap down. (Fig. 5.23)

#### Oil capacity

After overhauling the engine, fill crankcase with 0.9 lit (1.9 US pint, 1.58 Imp pint) of oil, however, during oil change, refill according to the level gauge.

#### Oil Brand and Grade

The grade of oil for the season is shown on the R. crankcase cover. Use the oil corresponding to MS, DG or DM in the A. P. I. service classification. (Fig. 5.24)

Below 0°C (32°F) ..... SAE 10W  
0~15°C (32~59°F) ..... SAE 20~20W  
above 15°C (59°F) ..... SAE 30

However, SAE group 10W-30 is an all weather oil and may be used over the normal range of outside temperature.



**NOTE:**

- a. Oil plays a prominent role in the life and the trouble free performance of an engine, therefore, it is very important that the oil changes be performed periodically and refrain from using dirty oil over a long period. The more frequent the oil change, the better it is for the engine.
- b. When refilling or adding oil, it should not be filled above the specified level. Overfilling will cause oil pumping and loss of power.
- c. Use only recommended oil.

**3. Greasing****1. Lubrication**

Apply grease to the grease nipples with grease gun until the grease is forced out at the clearances. (Fig. 5. 25)

Use multipurpose NLGI No. 2 grease.

**NOTE:**

- a. Clean the dirt from the nipple before greasing.
- b. Fit the grease gun nozzle securely to the nipple when greasing.
- c. Exercise care and do not permit the grease to become contaminated with dirt, dust or mixed with air.

**C. Drive Chain Adjustment**

An excessively slack drive chain will cause chain to whip, whereas, an over-tension condition will produce resistance, resulting in lower power output at the rear wheel. Always maintain the chain at the specified tension.

**1. Tension Checking Procedure**

- a. Remove the inspection hole cap on the chain case and check to see if the total vertical slack of the chain is between 1~2cm (0.4~0.8 in).
- b. Perform adjustment by loosening the axle nut ③ and sleeve nut ④ and then adjust with the adjusting nut. ⑥ (Fig. 5. 27)

Turn to the right to decrease chain slack.  
Turn to the left to increase chain slack.

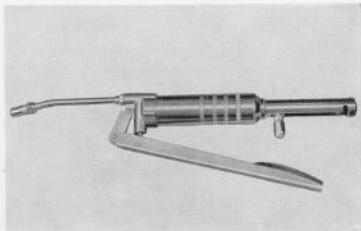
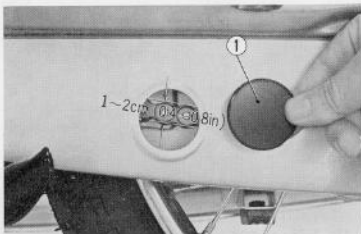
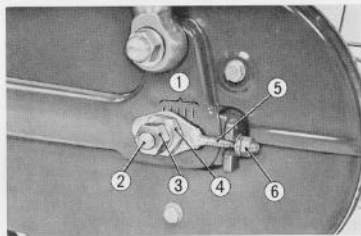

Fig. 5. 25 Grease gun

Fig. 5. 26 Inspecting drive chain tension  
① Inspection hole capFig. 5. 27 Adjusting the drive chain  
① Alignment mark  
② Rear wheel axle  
③ Axle nut  
④ Sleeve nut  
⑤ Adjuster  
⑥ Adjusting nut

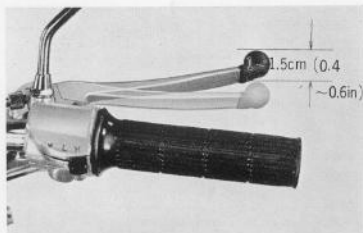

Fig. 5.28 Free play of brake lever

Fig. 5.29 Adjusting front brake lever  
① Adjusting nutFig. 5.30 Adjusting front brake lever  
① Front brake adjusting bolt  
② Lock nut

Fig. 5.31 Free play of brake pedal

**CAUTION:**

The adjusters should be at the same alignment marks for both the right and left sides after the adjustment has been completed.

c. Periodically clean and lubricate the chain.

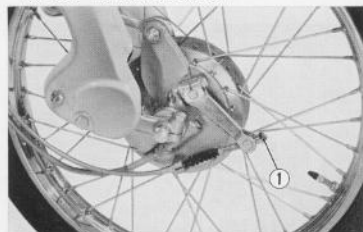
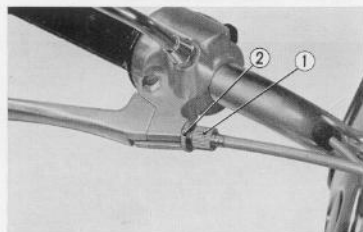
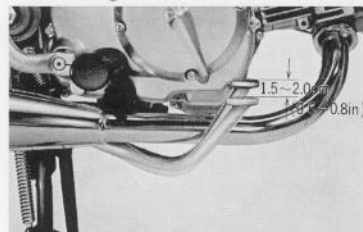
Lack of oil will cause the chain links to bind and resulting in excessive wear effect to the sprocket.

**D. Brake Adjustment**

Brakes are the life-line to the rider, therefore, do not neglect to perform the periodic inspection and correct any discrepancies no matter how minor.

**1. Front brake adjustment****1. Lever free play (Fig. 5.28)**

a. The free play of the brake lever, that is, the distance between the normal attitude and the point where the brake starts to take hold should be 1~1.5 cm (0.4~0.6 in).

b. Adjustment is made by the adjuster nut, ① (Fig. 5.29)

Turn to the right to decrease the free play.

Turn to the left to increase the free play.

c. Front brake adjustment can also be made at the front brake lever end. (Fig. 5.30)

Turn the adjusting bolt ① into the grip holder to increase the lever play and screw the adjusting bolt out to, decrease the play.

Tighten the lock nut ② after adjustment.

**2. Rear brake adjustment****1. Pedal free play**

a. The free play of the brake pedal, that is the distance between the normal attitude and the point where the brake starts to take hold should be 1.5~2 cm (0.6~0.8 in). (Fig. 5.31)

b. Adjustment is made by the adjuster nut. ① (Fig. 5.32)

Turn to the right to decrease pedal play.

Turn to the left to increase pedal play.

c. When the braking stroke is small, the following condition is apparent.

- (1) Too small a clearance between brake panel and shoe.
- (2) Loss of tension in the brake spring.
- (3) Brake lining damaged due to overheating.

### E. Muffler Cleaning

The function of the muffler is to muffle the noise of the exhaust gases as it is emitted from the combustion chamber. In the process, the carbon particles in the gas accumulates on the muffler and the diffuser pipe. Excess accumulation of the carbon will restrict the flow of the exhaust gas, creating back pressure which effects the engine performance by lowering the power output.

#### 1. Cleaning

- Remove the diffuser pipe locking bolt ① and pull out the diffuser pipe ② (Fig. 5.33) (diffuser pipe not removable on USA export)
- Tap the pipe lightly to remove the carbon and then wash in solvent or gasoline.

The clogging of the diffuser pipe will cause a drop in the engine power output.

A loose connection at the gasket joint will produce undesirable noise from leaking exhaust gas.

### F. Spoke Torquing

Riding with loose spoke will place on ununiform loading on the rim as well as on the remaining spokes, therefore, the spokes should be inspected frequently and retorqued when they become loose.

Raise the wheel off the ground and check each spoke for tightness, any spoke which are noticeably loose should be torqued to the same value as the remaining spokes. Use the spoke nipple tool and torquing wrench.

(Specified torque)

Front wheel: 4~21 kg·cm (0.3~1.5 ft·lb)

Rear wheel: 8~25 kg·cm (0.5~1.8 ft·lb)

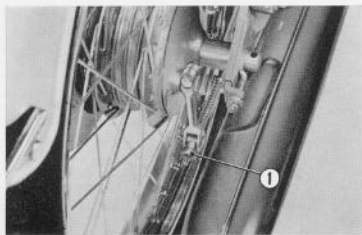

Fig. 5.32 Adjusting rear brake  
① Adjusting nut

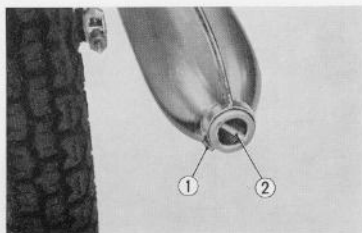

Fig. 5.33 Removing diffuser pipe  
① Locking bolt  
② Diffuser pipe

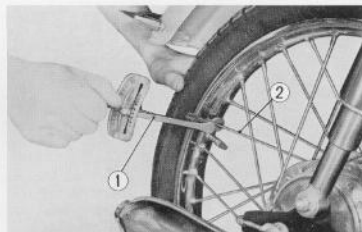

Fig. 5.34 Retorquing spokes  
① Spoke nipple tool  
② Spoke

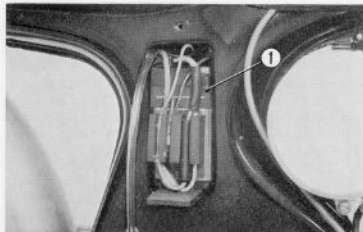

Fig. 5.35 Battery  
① Battery

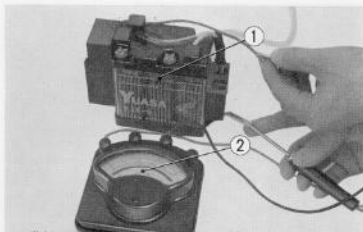

Fig. 5.36 Measuring voltage of battery  
① Battery  
② Volt meter



Fig. 5.37 Battery electrolyte level  
① Vent pipe  
② Upper level mark  
③ Lower level mark  
④ Filler cap

## G. Battery Inspection

Loss of battery electrolyte occurs after long use and should be replenished periodically. When the electrolyte level drops to the point where the plates are exposed, it will result in rapid discharge to the battery. Therefore, the battery should always be maintained at the proper electrolyte level.

### 1. Electrolyte Level

- a. Remove the battery box, disconnect the battery cable from the battery, unfasten the battery band and then remove the battery. (Fig. 5.35)
- b. Voltage of each batteries are as follows. (Fig. 5.36)

MODEL	TYPE	V-AH
S 90	MA 36-A B 36-6	6-6
CL 90, CL 90 L	MA 36-A B 36-6	6-6
CD 90	B 108-6	6-6
C 90	B 37-6 A	6-6
CT 90	B 37-6 A	6-5.5

- c. Always maintain the electrolyte level above the lower electrolyte level marking on the battery. When replenishing, add distilled water to raise the electrolyte level to the upper marking. (Fig. 5.37)
  - d. Replenish by removing the battery cap at the top and add the distilled water. All three battery cells should be filled to the same level.
2. Damaged and dirty Battery cable connector  
Inspect the connectors for cleanliness and damage. Clean the dirty connectors or replace damaged connectors before making connection and apply a coating of grease or vaseline on the connectors to prevent corrosion.
  3. Specific gravity

Check the specific gravity of all three cells of the battery with a hydrometer, if it measures below 1.220 the battery should be charged.

A fully charged battery should indicate a specific gravity of 1.280 at electrolyte temperature of 20°C (60°F). The specific gravity will vary somewhat with the temperature at the rate of 0.0007 specific gravity variation for each 1°C (1.8°F) change in temperature.

A rise in temperature will cause a decrease in specific gravity and visa versa. (Fig. 5.38)

**CAUTION:**

- (1) Do not add any sulfuric acid to the distilled water when replenishing.
- (2) When the drop in electrolyte level is rapid, check the discharge rate of the battery.
- (3) Exercise care not to pinch the battery cable when making the battery installation.
- (4) Also, make sure that the vent tube is not pinched.
- (5) When the temperature drops, the capacity of the battery will lower and cause hard starting. In such a case, store the motorcycle in a warm place.

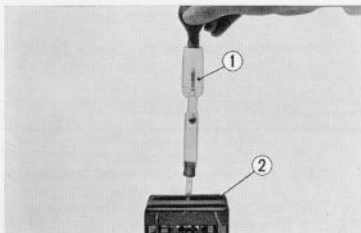

Fig. 5.38 Measuring specific gravity  
① Hydrometer  
② Battery

### H. Drive Chain Service

Drive chain which is kept clean and lubricated properly will provide longer service.

In addition, with a drive chain properly serviced the power transmission efficiency will increase by 10% or more. Therefore, service the drive chain for better driving.

**Servicing procedure**

1. Remove the drive chain and wash in cleaning oil (light oil). Use a brush to clean between links.
2. Drain oil thoroughly for at least 10 minutes.
3. Dissolve a cake of grease, which will not decompose by heating, heat to 50~120°C (122~248°F), and immerse the drive chain in the dissolved grease.

When adequate grease is not available, use mobile oil SAE 30~50, heated to 50°C (122°F).

Mobil oil mixed with petrolatum (1lit : 300g) will serve better for the purpose. Immersion time shall be approx. 10 min.

4. After the immersion, hang the drive chain to cool to normal temperature, then wipe the chain.
5. Install the drive chain on the motorcycle, perform trial rotation for a couple of minute and wipe off any spattered oil.

**NOTE:**

Some of greases which are called "Cup Grease" in shops may decompose by heating.

It is recommended that the drive chain be inspected every 1,500 km (1,000 mile).

## I. Operating Instructions for Service Tester, Type ST 4 B 4

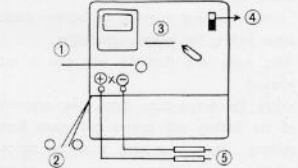
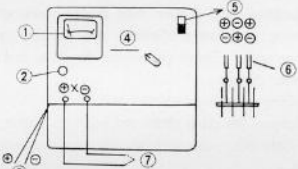
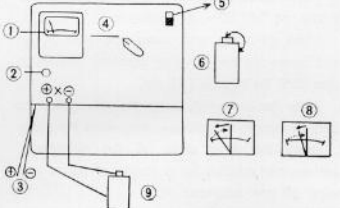
Item	Power	Direction for Use
Continuity test	6 or 12 volts	<p>Connect the test leads to the "X" terminals and attach the ends of the test leads to the part to be tested. If there is continuity, the red "Continuity" lamp will be lit. No lighting indicates that there is no continuity.</p> <p><b>Example:</b></p> <ol style="list-style-type: none"> <li>1. Light bulbs, shorted or open electrical circuit.</li> <li>1. Many other electrical continuity tests can be performed.</li> </ol>  <p>① Continuity lamp    ② Power 6 V or 12 V ③ Continuity        ④ ON                                  OFF ⑤ Test lead</p>
Resistance test	6 or 12 volts	<p>Short out the ends of the test leads connected to the "X" terminals and adjust the indicator needle of the resistance meter to "0" by the adjusting knob. Attach the ends of the test leads to the points across which the resistance is to be measured and read the meter indication.</p> <p><b>Example:</b></p> <ol style="list-style-type: none"> <li>1. Secondary ignition coil, 5,000~10,000 <math>\Omega</math></li> <li>1. Selenium rectifier normal direction, 5~40 <math>\Omega</math></li> <li>1. Selenium rectifier reverse direction, 600 <math>\Omega</math> min.</li> <li>1. In addition resistance across the points and many other uses.</li> </ol>  <p>① Black scale                    ② Adjusting knob ③ Power 6 V or 12 V        ④ Resistance ⑤ Turn the switch off       ⑥ Test lead ⑦ Short (Adjust the needle to "0")</p>
Insulation test	6 or 12 volts	<p>Short out the ends of the test leads connected to the "X" terminals and adjust the indicator needle of the insulation meter to "0" by the adjusting knob. Attach the ends of the test leads across the points to be measured and the insulation value is indicated on the meter.</p> <p><b>Example:</b></p> <ol style="list-style-type: none"> <li>1. Condenser insulation value Under 1M<math>\Omega</math> .....defective Condenser insulation value Over 5M<math>\Omega</math> .....satisfactory</li> <li>1. Various insulation tests may be performed.</li> </ol>  <p>① Black scale                    ② Adjusting knob ③ Power 6 V or 12 V        ④ Insulation ⑤ Turn the switch off       ⑥ Condenser                                  Discharge after the       Short out the terminal                                  measurement                ⑦ Over 5 M<math>\Omega</math> .....satisfactory ⑧ Under 1M<math>\Omega</math>...defective    ⑧ Condenser</p>

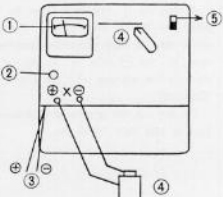
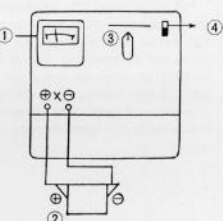
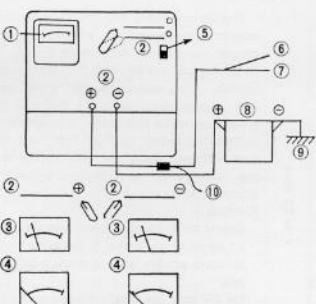
Item	Power	Direction for Use	
Condenser capacity test	6 or 12 volts	<p>With the initial resistance adjust the indicator needle of the meter to "0" by the adjusting knob and position the switch to "Condenser". Attach the ends of the test leads to the test condenser terminals and read the capacity on the meter.</p> <p>Range of measuring value : 0.3~0.3 <math>\mu</math>F</p>	 <p>① Red scale ③ Power (6 V or 12 V) ⑤ Turn the switch</p> <p>② Adjusting knob ④ Condenser</p>
		<p>Attach the red test lead from the "X" terminal to the <math>\oplus</math> side and the black test lead from the "X" terminal to the <math>\ominus</math> side of the test part and read the measurement on the meter.</p> <p><b>Example:</b></p> <ol style="list-style-type: none"> <li>Battery terminal voltage</li> <li>Measuring the output of the D. C. dynamo</li> </ol>	 <p>① Blue scale ③ D. C. voltage</p> <p>② Battery ④ Turn the switch off</p>
D. C. current $\oplus \ominus$	Not required	<p>Connect the D. C. current measuring leads to the D. C. current terminals. When the current enters the red terminal and leaves from the black terminal, the indicator needle of the meter swings to the normal direction. With the connection mentioned above, if the indicator needle swings to the reverse direction, switch to this position and the indicator needle of the meter swings to the normal direction.</p> <p>[Caution]</p> <p>If the connection is not correct, fuse (15 A) will be blown. When the indicator needle of the meter does not swing, inspect the fuse.</p> <p><b>Example:</b></p> <ol style="list-style-type: none"> <li>The charge or discharge condition of the battery</li> <li>Measuring the current consumption of the flasher, horn, light, etc.</li> </ol>	 <p>① Yellow scale ③ Charge ⑤ Turn the switch off ⑦ Selenium rectifier ⑧ Battery ⑨ Mounted on chassis</p> <p>② D. C. current ④ Discharge ⑥ Switch ⑩ 15 A fuse</p>

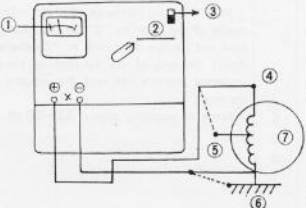
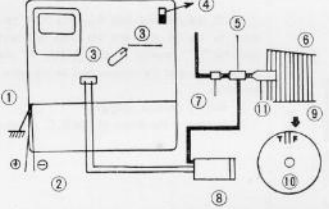
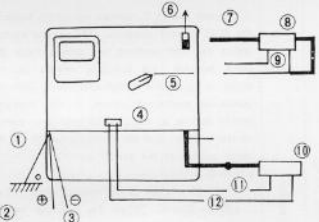
Item	Power	Direction for Use	
A. C. voltage measurement	Not required	<p>Attach the ⊕ test lead from the "X" terminal to the ⊕ side of the dynamo (A. C.) either day or night operation) and the ⊖ test lead to the ⊖ side or to the chassis and measure the voltage with the engine running.</p> <p><b>[Caution]</b> Do not run the engine at high speed. Measure at less than 2,000 rpm.</p>	 <p>① Blue graduation ② Turn the switch off ③ Night ④ Dynamo (A. C.) ⑤ A. C. voltage ⑥ Day ⑦ Chassis</p>
Timing test	6 or 12 volts	<p>Plug in the timing light attachment into the timing receptacle. Next, attach the timing light high tension cord to the hex bar installed on the head of the spark plug. Position the switch to "Timing", start the engine and the timing light will start flashing. Point the light to the flywheel or to other rotating parts and the ignition timing and spark advancing can be inspected.</p>	 <p>① Earth ② Timing ③ Hex bar ④ Engine ⑤ Timing light ⑥ Rotor ⑦ Power 6 V or 12 V ⑧ The switch may be tuned either ON or OFF ⑨ Plug cap ⑩ Ignition timing alignment mark</p>
Coil test	6 or 12 volts	<p>Plug the crow foot plug into the crow foot receptacle to connect the primary coil, and connect the red test lead to the ⊕ side of the primary coil and the white test lead to the ⊖ side. Then, connect the high tension cord from the upper RH corner of the pocket in the tester body to the high tension secondary coil. Position the switch to "Coil Test" and the spark will jump across the three needle test gap. Measure the spark gap by turning the adjustment knob.</p> <p><b>[Caution]</b> Ground the black ground cord from the upper LH corner of the pocket in the tester body to avoid possible electric shocks during the test.</p> <p>For 6 V coils, use 6 volts power and 12 volts power for 12 V coils.</p>	 <p>① Black ② Earth ③ Power (For 6 V coils, use 6 V power and use 12 V power for 12 V coils) ④ Primary coil ⑤ The switch may be turned either on or off ⑥ Coil ⑦ For common use ⑧ White ⑨ Reverse ⑩ Coil test ⑪ High tension secondary (For simultaneous ignition) ⑫ Primary coil ⑬ Red ⑭ Normal</p>

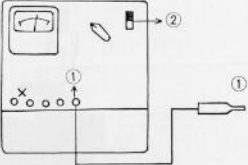
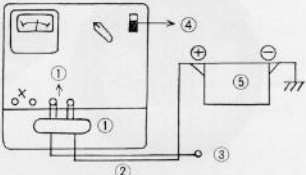

Item	Power	Direction for Use
Transistor tachometer unit attachment	Not required	<p data-bbox="304 193 575 278">Use the transistor tachometer unit attachment in the timing test started above for measuring the revolution of the engine, the revolution for the charge starting and the revolution for the governor advancing, etc. 0~6,000 rpm.</p>  <p data-bbox="646 371 894 388">① Tachometer ② Turn the switch on</p>
Shunt unit attachment	Not required	<p data-bbox="304 422 575 504">The shunt unit attachment is used for measuring the starter current, the current under no load and for testing the selfstarting motor performance. 0~60 A</p>  <p data-bbox="607 605 926 655">① Shunt ② Wiring diagram for starter current measurement ③ Starter cord ④ Turn the switch off ⑤ Battery</p>
Caution		<ol data-bbox="261 690 745 806" style="list-style-type: none"> <li>1. The service tester shall be operated gently and the switch must be turned off when not in use.</li> <li>2. When the power indicator lamp is not lit with the battery connected, the probable causes of the trouble are either blown fuse or defective vibrator.</li> <li>3. When using the timing light, the service tester is operating, however, the timing light is not lit, the bulb (xenon tube) is probably defective and should be replaced.</li> </ol>

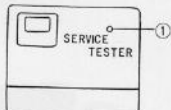

① Power Indicator lamp

## J. Security Inspection of Parts

## MODEL S 90, (CL 90, CL 90 L)

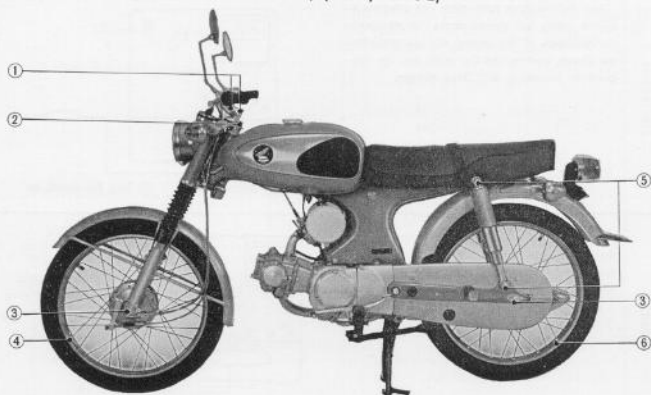

Fig. 5.39 Torquing points on left side



Fig. 5.40 Torquing points on right side

- ① Handle installation nut  
(90~110 kg·cm; 6.5~7.95 lbs·ft)
- ② Steering stem nut  
(800 kg·cm; 58 lbs·ft)
- ③ Front and rear axle nut  
(300~400 kg·cm; 21.7 lbs·ft)
- ④ Front wheel spoke  
(4~21 kg·cm; 0.3~1.5 lbs·ft)
- ⑤ Rear cushion upper and lower nuts  
(300~400 kg·cm; 21.7~25.3 lbs·ft)

- ⑥ Rear wheel spokes  
(8~25 kg·cm; 0.58~1.8 lbs·ft)
- ⑦ Rear fork pivot nut  
(300~400 kg·cm; 21.7~25.3 lbs·ft)
- ⑧ Rear brake torque link nut  
(80~100 kg·cm; 5.8~7.2 lbs·ft)
- ⑨ Engine mounting bolts and nuts  
(200~250 kg·cm; 14.5~18 lbs·ft)

## MODEL CD 90, (CT 90)



Fig. 5.41 Torquing points on left side



Fig. 5.42 Torquing points on right side

- |  |  |
|--|--|
| ① Handle installation nuts<br>(90~110 kg·cm; 6.5~7.95 lbs·ft)    | ⑧ Rear cushion upper and lower nuts<br>(300~400 kg·cm; 21.7~25.3 lbs·ft) |
| ② Steering stem nut<br>(800 kg·cm; 56 lbs·ft)                    | ⑨ Rear wheel spokes<br>(6~25 kg·cm; 0.55~1.8 lbs·ft)                     |
| ③ Front cushion upper bolts<br>(300~400 kg·cm; 21.7~25.3 lbs·ft) | ⑩ Front brake torque link lock nuts<br>(300~400 kg·cm; 21.7~25.3 lbs·ft) |
| ④ Front arm pivot bolts<br>(300~400 kg·cm; 21.7~25.3 lbs·ft)     | ⑪ Engine hanger nuts<br>(200~250 kg·cm; 14.5~18 lbs·ft)                  |
| ⑤ Front and rear axle nut<br>(300~400 kg·cm; 21.7~25.3 lbs·ft)   | ⑫ Rear fork pivot nut<br>(200~250 kg·cm; 14.5~18 lbs·ft)                 |
| ⑥ 8×46 hex bolt<br>(300~400 kg·cm; 21.7~25.3 lbs·ft)             | ⑬ Rear brake torque link nut<br>(200~250 kg·cm; 14.5~18 lbs·ft)          |
| ⑦ Front wheel spokes<br>(4~21 kg·cm; 0.3~1.5 lbs·ft)             |  |

## MODEL C 90



Fig. 5.43 Torquing points on left side



Fig. 5.44 Torquing points on right side

- |  |   |
|--|---|
| ① Handle installation nuts<br>(90~110 kg·cm : 6.5~7.95 lbs·ft)   | ⑦ Rear cushion upper and lower nuts<br>250~300 kg·cm : 18~21.7 lbs·ft)          |
| ② Steering stem nut<br>(800 kg·cm : 68 lbs·ft)                   | ⑧ Rear wheel spokes<br>8~25 kg·cm : 0.58~1.8 lbs·ft)                            |
| ③ Front and rear axle nuts<br>(300~400 kg·cm : 21.7~25.3 lbs·ft) | ⑨ Front brake panel stopper and torque bolt<br>(200~250 kg·cm : 14.5~18 lbs·ft) |
| ④ 8×46 hex bolt nuts<br>(300~400 kg·cm : 21.7~25.3 lbs·ft)       | ⑩ Engine hanger nuts<br>(200~250 kg·cm : 14.5~18 lbs·ft)                        |
| ⑤ Front arm pivot nuts<br>(300~400 kg·cm : 21.7~25.3 lbs·ft)     | ⑪ Rear fork pivot nut<br>(200~250 kg·cm : 14.5~18 lbs·ft)                       |
| ⑥ Front wheel spokes<br>(4~21 kg·cm : 0.3~1.5 lbs·ft)            | ⑫ Rear brake torque link nut<br>(100~200 kg·cm : 7.2~14.5 lbs·ft)               |

## 5.2 PERIODIC INSPECTION AND SERVICING

## MODEL S 90

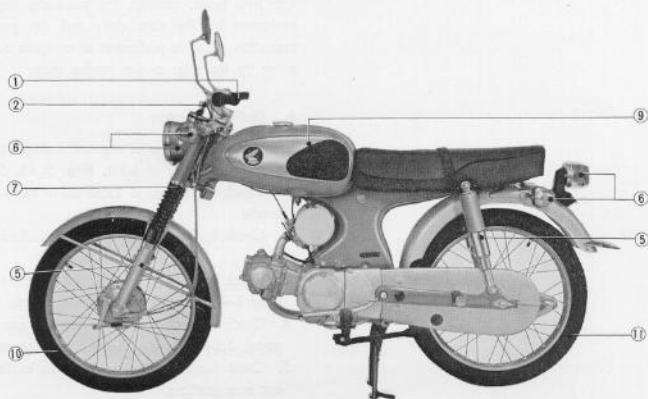

Fig. 5.45 Daily inspection points on left side

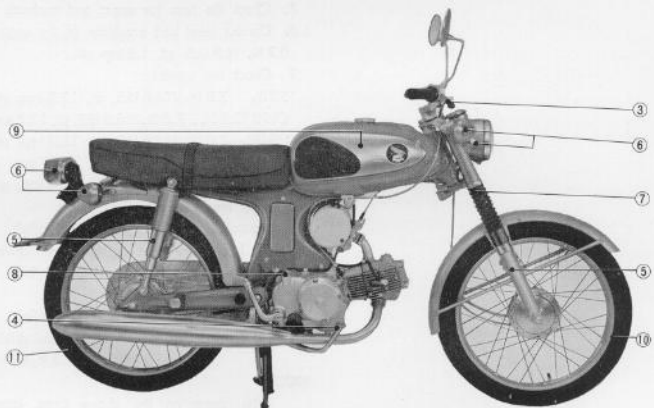

Fig. 5.46 Daily inspection points on right side

It is of utmost importance to perform periodical inspection and servicing so that troubles can be prevented and the motorcycle maintained in the best of operating condition. The inspection is classified into two types, namely, the pre-riding inspection performed by the rider daily and the periodical inspection which is performed at a regular schedule either by the rider or the service shop.

#### A. Daily Inspection

The following items of inspection should be performed as a matter of habit. (Fig. 5.45, 5.46)

1. Check for excessive looseness or sway of the handle.
2. Check for proper free play of the clutch brake lever.
3. Check for proper free play of the front brake lever 1~1.5 cm (0.4~0.6 in) is normal.
4. Check for proper free play of the rear brake pedal, 1.5~2.0 cm (0.6~0.8 in) is normal.
5. Check for looseness and oil leaks in the front and rear cushions.
6. Check the function of the headlight, taillight, stoplight and turn signal lights.
7. Check the horn for sound and loudness.
8. Correct level and condition of the engine oil  
0.9 lit. (1.9 U.S. pt, 1.6 Imp pt).
9. Check fuel quantity.  
S 90 : 7.0 lit. (14.8 U.S. pt, 12.3 Imp. pt)  
CL90/CL90L : 7.5 lit. (15.8 U.S. pt, 13.2 Imp. pt)  
CD 90 : 7.0 lit. (14.8 U.S. pt, 12.3 Imp. pt)  
C 90 : 5.5 lit. (11.6 U.S. pt, 0.97 Imp. pt)  
CT 90 : 6.5 lit. (13.7 U.S. pt, 11.4 Imp. pt)
10. Front tire air pressure.  
Normal ..... 1.8 kg/cm<sup>2</sup> (25.6 lb/in<sup>2</sup>)  
For loaded condition or high speed driving  
..... 2.0 kg/cm<sup>2</sup> 28.5 lb/in<sup>2</sup>
11. Rear tire air pressure.  
Normal ..... 2.0 kg/cm<sup>2</sup> (28.5 lb/in<sup>2</sup>)  
For loaded condition or high speed driving.  
..... 2.2 kg/cm<sup>2</sup> (31.3 lb/in<sup>2</sup>)

#### NOTE:

After inspecting the above items, attention should be paid to the following points when riding.

- (1) After starting, warm up the engine for two minutes at low speed.

When the engine is cold, the viscosity of the oil is heavy and does not permit ade-

- quate lubrication to all parts.
- (2) Do not race the engine needlessly.
  - (3) Refrain from abrupt acceleration or braking, tight cornering.
  - (4) Check battery electrolyte level weekly without fail. Under the following conditions, checks should be made at a more frequent intervals.
    - a. Riding in mountainous area.
    - b. More frequent inspection is necessary when riding at high speed.

### B. Periodic Inspection

Periodic inspection and servicing should be performed in accordance with the following table.

Items	Intervals by speedometer or mile or km		300	1,000	2,000	3,000	4,000	5,000	6,000	7,000	8,000	9,000	10,000	11,000	12,000
	500	1,500	3,000	4,500	6,000	7,500	9,000	10,500	12,000	13,500	15,000	16,500	18,000		
Change engine oil	◆	◆	◆	◆	◆	◆	◆	◆	◆	◆	◆	◆	◆	◆	◆
Adjust ignition timing				◆					◆			◆			◆
Adjust valve clearance	◆			◆					◆			◆			◆
Adjust clutch		◆		◆					◆			◆			◆
Adjust carburetor				◆					◆			◆			◆
Adjust drive chain	◆	◆	◆	◆	◆	◆	◆	◆	◆	◆	◆	◆	◆	◆	◆
Adjust front and rear brakes		◆	◆	◆	◆	◆	◆	◆	◆	◆	◆	◆	◆	◆	◆
Clean spark plug				◆					◆			◆			◆
Clean oil filter	◆								◆						◆
Clean air cleaner				◆					◆			◆			◆
Clean fuel strainer				◆					◆			◆			◆
Clean muffler									◆						◆
Check tightness of spokes		◆							◆						◆
Tighten nuts and bolts		◆							◆						◆
Adjusting lighting equipment and horn				◆					◆			◆			◆
Check battery	◆	◆	◆	◆	◆	◆	◆	◆	◆	◆	◆	◆	◆	◆	◆

Perform the periodical inspections on the scheduled mileages shown in the chart to maintain the motorcycle in the peak of condition and be assured of extended trouble-free service.

## 6. TROUBLE SHOOTING

It is most important that the cause of any trouble be located as soon as possible and positive corrective action taken so that the serviceable life of the engine will be extended.

In the following table are listed the troubles, probable causes and the corrective actions.

### 6.1 MAIN ENGINE TROUBLE

Troubles	Probable causes	Corrective action
Engine will not continue running	<ol style="list-style-type: none"> <li>1. Clogged fuel cock</li> <li>2. Plugged vent hole in fuel tank cap.</li> <li>3. Improper tappet clearance</li> <li>4. The carburetor to intake manifold connecting tube damaged or leaking air at the joints</li> <li>5. Improper oil level</li> </ol>	Clean and inspect
Engine malfunctions after warm-up	<ol style="list-style-type: none"> <li>1. Defective spark plug</li> <li>2. Defective ignition coil</li> <li>3. Incorrect float level</li> </ol>	<ol style="list-style-type: none"> <li>1. Overheated spark plug, replace with plug of correct heat range</li> </ol>
Excessive smoke at high engine speed. (oil pumping condition)	<ol style="list-style-type: none"> <li>1. Oil being pumped into the combustion chamber due to excessively worn or damaged cylinder, piston, rings and burns during combustion</li> </ol>	By diagnosing the cause, retore and/or replace the parts as required
Noise produced near the top of the engine	<ol style="list-style-type: none"> <li>1. Worn piston and cylinder The clearance between the piston and cylinder is increased causing the piston skirt to slap against cylinder wall during combustion</li> <li>2. Worn connecting rod large end produces knocking</li> <li>3. Tappet noise</li> </ol>	<ol style="list-style-type: none"> <li>1. Inspect and rebore cylinder and replace worn parts</li> <li>2. Replace connecting rod, large end bearing and crank pin</li> <li>3. Adjust to proper specification</li> </ol>
Overheating engine	<ol style="list-style-type: none"> <li>1. Carbon deposit accumulation</li> <li>2. Dirty or fouled spark plug</li> <li>3. Improper type spark plug or gap</li> <li>4. Insufficient lubrication to drive chain or chain tension too tight</li> <li>5. Oil level too low, poor or improper grade oil</li> <li>6. Improper contact breaker point gap clearance, dirty, burnt</li> <li>7. Excessive carbon accumulation in combustion chamber</li> </ol>	<ol style="list-style-type: none"> <li>1. Disassemble and clean</li> <li>2. Clean, dry fouled plug. Inspect carburetor if plug continues to foul</li> <li>4. Adjust periodically, lubricate</li> <li>7. Adjust periodically</li> </ol>
Engine does not start (lack of compression)	<ol style="list-style-type: none"> <li>1. Foreign object caught between valve and valve seat</li> <li>2. Valve tappet stuck open</li> <li>3. Ignition timing out of adjustment</li> <li>4. Blown fuse</li> </ol>	<ol style="list-style-type: none"> <li>1. Disassemble and clean</li> <li>2. Adjust</li> <li>3. Adjust</li> <li>4. Replace</li> </ol>



Troubles	Probable causes	Corrective action
Engine suddenly stalls while running	<ol style="list-style-type: none"> <li>1. Clogged fuel cock</li> <li>2. Fuel passage in the carburetor clogged</li> <li>3. Dirty spark plug (heavy carbon deposit or wet plug)</li> <li>4. Ignition timing out of adjustment</li> <li>5. Blown fuse</li> </ol>	<ol style="list-style-type: none"> <li>1. Disconnect the fuel line and check the fuel flow</li> <li>2. If the fuse is blown, the pilot lamps will not light up</li> </ol>
Oil becomes emulsified (especially during winter)	<ol style="list-style-type: none"> <li>1. Water mixed with oil</li> <li>2. Use of improper type oil</li> <li>3. Clogged breather pipe</li> </ol>	<p>(Caution)</p> <p>The oil, even though clean in appearance, may decompose due to extended use and become thin, resulting in loss of lubricating properties. Should be replaced.</p>
<p>Increased fuel consumption.</p> <p>Condition:</p> <ol style="list-style-type: none"> <li>1. Low exhaust noise, low back pressure of muffler</li> <li>2. Low compression noticeable when kick starting</li> </ol>	<ol style="list-style-type: none"> <li>1. Clogged air cleaner</li> <li>2. Contact breaker point gap out of adjustment, dirty burnt</li> <li>3. Excess accumulation of carbon in cylinderhead, exhaust port or inside muffler</li> <li>4. Ignition timing retarded</li> </ol>	<ol style="list-style-type: none"> <li>1. Clean air cleaner element</li> <li>2. Adjust gap clearance, rework or replace burnt points</li> <li>4. If ignition timing is retarded, the contact breaker points will open after the timing mark "F" has been passed. Adjust to proper setting.</li> </ol>
Insufficient engine RPM	<ol style="list-style-type: none"> <li>1. Fuel passage clogged</li> <li>2. Defective spark plug (fouled)</li> <li>3. Clogged air cleaner</li> <li>4. Ignition timing out of adjustment</li> </ol>	<ol style="list-style-type: none"> <li>1. When the fuel passage is clogged, the spark plugs will be dry</li> <li>2. If the air cleaner is clogged, engine will not develop high RPM and the exhaust smoke becomes dark. Clean the air filter element periodically</li> </ol>
Poor throttle response (first check to see that the throttle cable is properly adjusted)	<ol style="list-style-type: none"> <li>1. Clogged air cleaner</li> <li>2. Clogged exhaust port or exhaust pipe</li> <li>3. Ignition timing out of adjustment</li> <li>4. Tappet clearance out of adjustment</li> </ol>	
Contact breaker points burnt	<ol style="list-style-type: none"> <li>1. Points covered with oil</li> <li>2. Improper ignition timing</li> <li>3. Defective condenser</li> <li>4. Condenser in poor condition</li> </ol>	Test condenser by method described in test procedure

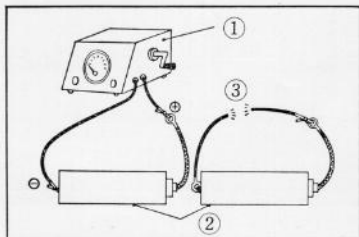

Fig. 6.1 Measuring condenser capacity

- ① Service tester
- ② Condenser
- ③ Spark

### Condenser test method

After taking the resistance value with the meger, use a copper wire to short across the terminals, a good strong spark should be produced at the instance the lead are contacted.

### Condenser measurement

With the contact breaker point open, measure the resistance between the primary terminal and the outer shell, a good condenser should be measured at least 5 M $\Omega$  resistance at standard temperature.

The condenser is defective if it measures below 1 M $\Omega$ .

### CAUTION:

A loose installation of the condenser or dirty terminal will cause ignition to malfunction.

## 6.2 CARBURETOR TROUBLE

Troubles	Probable causes	Corrective action
1. Fuel overflow (related symptom) Poor idling Poor performance in all speed Excessive fuel consumption Hard starting Low power output Poor acceleration	1. Contaminated fuel	1. Remove float chamber cover (C 90, CT 90, CD 90) 2. Remove locking clip and disassemble the float chamber (S 90, CL 90, CL 90 L) 3. Check for any dirt lodge in the valve seat, remove dirt by blowing with compressed air or by unscrewing the valve seat, and clean 4. Reassemble after cleaning in gasoline
	2. Damaged valve or valve seat	2. Replace both the valve and valve seat with new parts
	3. Punctured float	3. Remove the float chamber cover, take out the float and check for fuel in the float (Checking procedure) Shake the float Immerse the float in hot water 90~95°C (194~203°F) for approximately 50, 60 seconds; bubbles can be observed if the float is punctured
	4. Float arm lip bent	4. Straighten the arm lip if bent and use the fuel level gauge to obtain the proper fuel level
2. Poor idling (related symptom) Poor performance at low speed Poor speed transition Poor response to throttle snapping Poor performance at Intermediate speed	1. Air screw improperly adjusted	1. Turn the air screw lightly to full close and check to see if the air screw was properly adjusted. Back off $1\frac{1}{4} \pm \frac{1}{8}$ (S 90, CD 90) turn from full close, (1 $\frac{1}{8}$ turn for CL 90, CL 90 L, CT 90 and 1.0 turn for C 90). Start the engine and turn the air screw in both direction not more than 1/4 turn and set at the point where the engine RPM is highest (smooth)
	2. Throttle stop screw out of adjustment	2. Back off the throttle stop screw all the way and check for proper operation of the throttle, turn the stop screw in until the proper rpm is obtained

Troubles	Probable causes	Corrective action
	3. Clogged slow jet	3. Unscrew the plug, remove and check for any dirt, blow out with compressed air if dirty. Remove the slow jet and clean in the same manner



Fig. 6.2 Adjusting the Idling (S 90)

① Throttle stop screw      ② Air screw

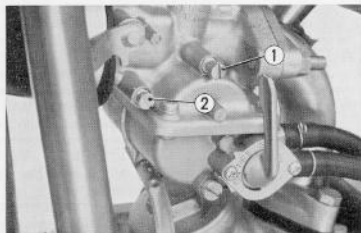

Fig. 6.3 Adjusting the Idling (CT 90)

① Throttle stop screw      ② Air screw

Troubles	Probable causes	Corrective action
3. Poor performance at intermediate speed (related symptom) Flat spot Poor acceleration Excessive fuel consumption Poor speed transition	1. Same corrective action as for poor idling	1. Clogged slow jet
	2. Jet needle at improper setting	2. Adjust to the proper stage
	3. Improper fuel level	3. Replace worn jet needle with new part. Use the fuel level gauge and adjust the level by bending the float arm lip
	4. Clogged air vent	4. Clean out the air vent
4. Poor high speed performance (related symptom) ◦ Loss of power ◦ Poor acceleration ◦ Black exhaust ◦ Poor engine performance	1. Loose main jet or clogged with dirt	1. Remove main jet and clean, install and tighten securely
	2. Clogged air vent tube	2. Clean out vent tube
	3. Choke closed	3. Open the choke to full OPEN position
	4. Fuel cock improperly positioned	4. Position the fuel cock lever to full OPEN position
	5. Loose jet needle	5. If jet needle locking clip is broken, replace with a new part
5. Hard starting	1. Excessive use of choke	1. Start engine with choke valve fully open (clean spark plug)
	2. Fuel overflow	2. Same corrective action as 1 above
	3. Fuel cock in closed position	3. Open fuel cock

## 6.3 ENGINE NOISE

Troubles	Probable causes	Corrective action
1. Tappet noise	1. Excessive valve tappet clearance	1. Adjust to proper clearance
	2. Worn tappet	2. Repair or replace

Troubles	Probable causes	Corrective action
2. Piston slap	<ol style="list-style-type: none"> <li>1. Worn piston, cylinder</li> <li>2. Carbon deposit in combustion chamber</li> <li>3. Worn piston pin bore, connecting rod small end</li> </ol>	<ol style="list-style-type: none"> <li>1. Repair or replace</li> <li>2. Remove carbon</li> <li>3. Repair or replace</li> </ol>
3. Cam chain noise	<ol style="list-style-type: none"> <li>1. Stretched chain</li> <li>2. Worn teeth on cam sprocket, timing sprocket</li> </ol>	<ol style="list-style-type: none"> <li>1. Replace</li> <li>2. Replace</li> </ol>
4. Clutch knock	<ol style="list-style-type: none"> <li>1. Worn clutch plate outer tab area</li> <li>2. Worn clutch center spline</li> </ol>	<ol style="list-style-type: none"> <li>1. Repair or replace</li> <li>2. Repair or replace</li> </ol>
5. Crankshaft	<ol style="list-style-type: none"> <li>1. Crankshaft end play</li> <li>2. Worn crankshaft bearing</li> </ol>	<ol style="list-style-type: none"> <li>1. Repair or replace</li> <li>2. Repair or replace</li> </ol>
6. Engine noise (magneto noise)	<ol style="list-style-type: none"> <li>1. Chafing between kick arm and oil seal</li> <li>2. Breaker point noise, defective slipper surface</li> </ol>	<ol style="list-style-type: none"> <li>1. Repair</li> <li>2. Replace A. C. generator assembly</li> </ol>

#### 6.4 STEERING SYSTEM

Troubles	Probable causes	Corrective action
1. Handle operates heavy	<ol style="list-style-type: none"> <li>1. Overtorqued steering cone race</li> <li>2. Damaged steering steel balls</li> <li>3. Bent steering stem</li> </ol>	<ol style="list-style-type: none"> <li>1. Readjust</li> <li>2. Replace</li> <li>3. Bent steering stem</li> </ol>
2. Front or rear wheel	<ol style="list-style-type: none"> <li>1. Loose bearing in front or rear wheel</li> <li>2. Bent rim on front or rear wheel</li> <li>3. Loose spoke</li> <li>4. Worn rear fork pivot bushing</li> <li>5. Twisted frame</li> <li>6. Drive chain adjuster out of adjustment</li> </ol>	<ol style="list-style-type: none"> <li>1. Check for wear and replace as required</li> <li>2. Straighten by loosening or tightening the spokes</li> <li>3. Replace if uncorrectable</li> <li>4. Replace</li> <li>5. Repair or replace</li> <li>6. Adjust to proper value</li> </ol>
3. Pulls to one side	<ol style="list-style-type: none"> <li>1. Right and left cushions not balanced, front or rear</li> <li>2. Misalignment of front and rear cushions</li> <li>3. Bent front fork</li> <li>4. Bent rear fork</li> <li>5. Bent front axle</li> <li>6. Loose component in steering system</li> </ol>	<ol style="list-style-type: none"> <li>1. Replace</li> <li>2. Replace</li> <li>3. Repair</li> <li>4. Repair</li> <li>5. Repair</li> <li>6. Repair</li> </ol>

#### 6.5 CLUTCH SYSTEM

Troubles	Probable causes	Corrective action
1. Clutch slips	<ol style="list-style-type: none"> <li>1. Loss of tension in clutch springs</li> <li>2. Worn or warped clutch plate</li> <li>3. Worn or warped clutch friction disc</li> </ol>	<ol style="list-style-type: none"> <li>1. Replace</li> <li>2. Replace</li> <li>3. Repair or replace</li> </ol>
2. Clutch will not disengage	<ol style="list-style-type: none"> <li>1. Excessively worn clutch friction disc</li> <li>2. Improper adjustment</li> </ol>	<ol style="list-style-type: none"> <li>1. Repair or replace</li> <li>2. Adjust to proper specification</li> </ol>

Troubles	Probable causes	Corrective action
3. Clutch out of adjustment (engine stalls)	1. Warped clutch plate or friction disc 2. Uneven tension of clutch spring	1. Repair 2. Measure tension and repair or replace

## 6.6 GEAR CHANGE SYSTEM

Troubles	Probable causes	Corrective action
1. Gears will not engage	1. Broken lug on shift drum 2. Broken lug on shift arm 3. Unsmooth movement between shift drum and shift fork 4. Broken shift fork 5. Broken lug on counter shaft second gear 6. Broken lug on main shaft second and third gear	1. Replace 2. Replace 3. Repair 4. Replace 5. Replace 6. Replace
2. Gear change pedal not returning	1. Broken shift return spring 2. Gear shift spindle rubbing against case or cover	1. Replace 2. Repair
3. Gear jumps out of engagement	1. Worn lug on counter shaft second gear 2. Worn lug on main shaft second and third gear 3. Worn or bent shift fork 4. Broken or loss of tension of shift drum stopper spring	1. Repair or replace 2. Repair or replace 3. Replace 4. Replace

## 6.7 SUSPENSION

Troubles	Probable causes	Corrective action
1. Soft suspension	1. Loss of spring tension 2. Excessive load	1. Replace
2. Hard suspension	1. Ineffective front cushion damper 2. Ineffective rear cushion damper	
3. Suspension noise	1. Cushion case rubbing 2. Interference between cushion case and spring 3. Damaged cushion stopper rubber 4. Insufficient spring damper oil (front and rear)	1. Inspect cushion spring and case 2. Repair 3. Replace 4. Replace

## 6.8 BRAKE SYSTEM

Troubles	Probable causes	Corrective action
1. No range of adjustment	1. Worn brake shoe 2. Worn brake cam slipper 3. Worn brake cam	1. Replace 2. Replace 3. Replace

Troubles	Probable causes	Corrective action
2. Unusual noise when applied	1. Worn brake shoe 2. Foreign object lodged in brake lining 3. Pitted brake drum surface 4. Worn brake panel bushing	1. Replace 2. Remove foreign object 3. Repair 4. Replace
3. Ineffective braking	1. Inoperative front brake cable 2. Loose brake rod 3. Improper brake shoe contact 4. Dirt or water inside the brake	1. Remove foreign object from cable and inspect for bends 2. Inspect and repair 3. Inspect and repair 4. Inspect and repair

## 6.9 DRIVE CHAIN

Troubles	Probable causes	Corrective action
1. Drive chain stretches frequently	1. Excessive load applied to chain (during riding or gear change) 2. Due to oil leak, excessive lubrication periodically	1. Correct riding technique 2. Perform proper lubrication
2. Excessively worn sprocket	1. Driving with worn sprocket 2. Sprocket mal fitted to drive chain	1. Clean sprocket area 2. Replace with proper sprocket

# 7. WIRING DIAGRAM

S 90 GENERAL EXPORT TYPE

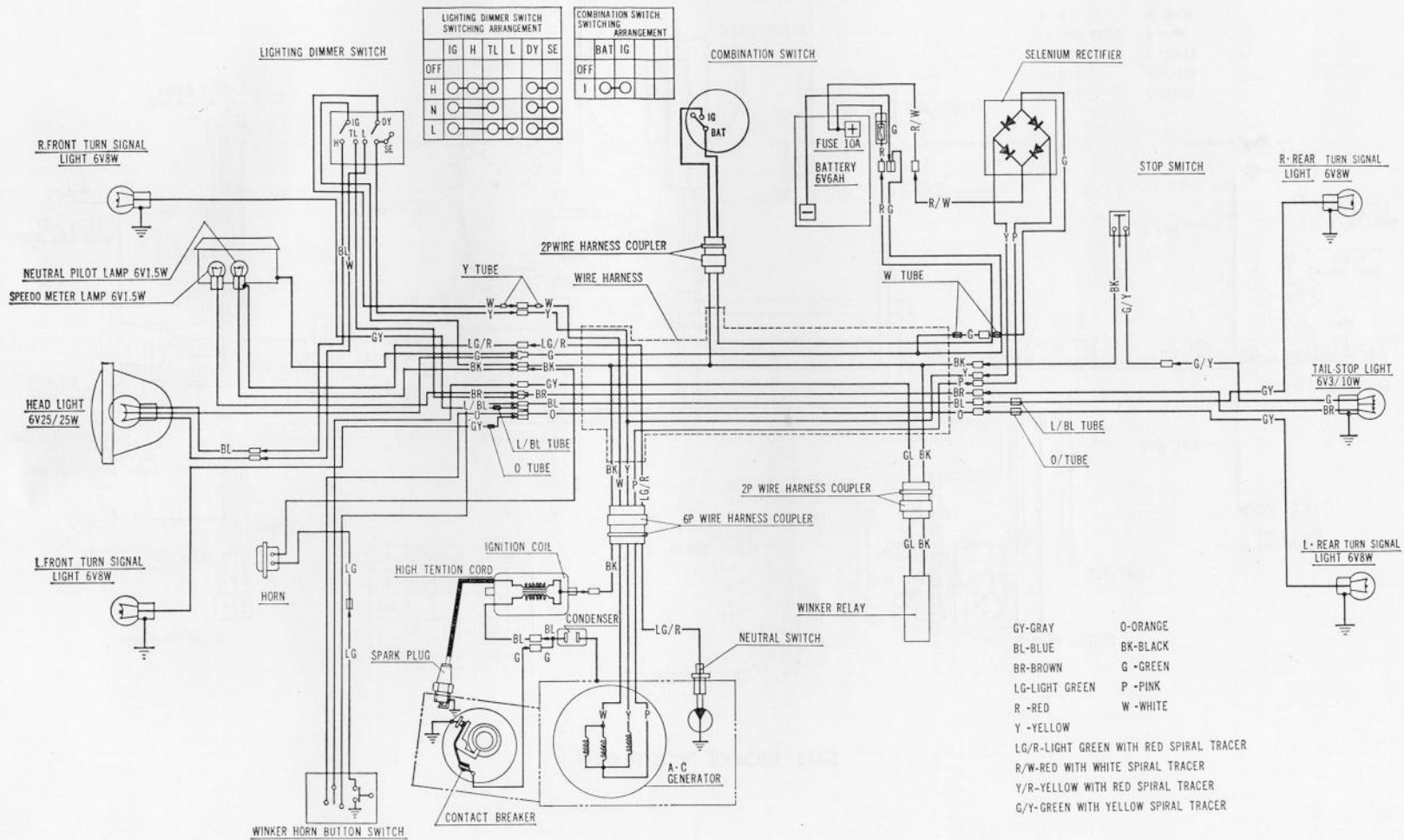

S 90 U. S. A. EXPORT TYPE

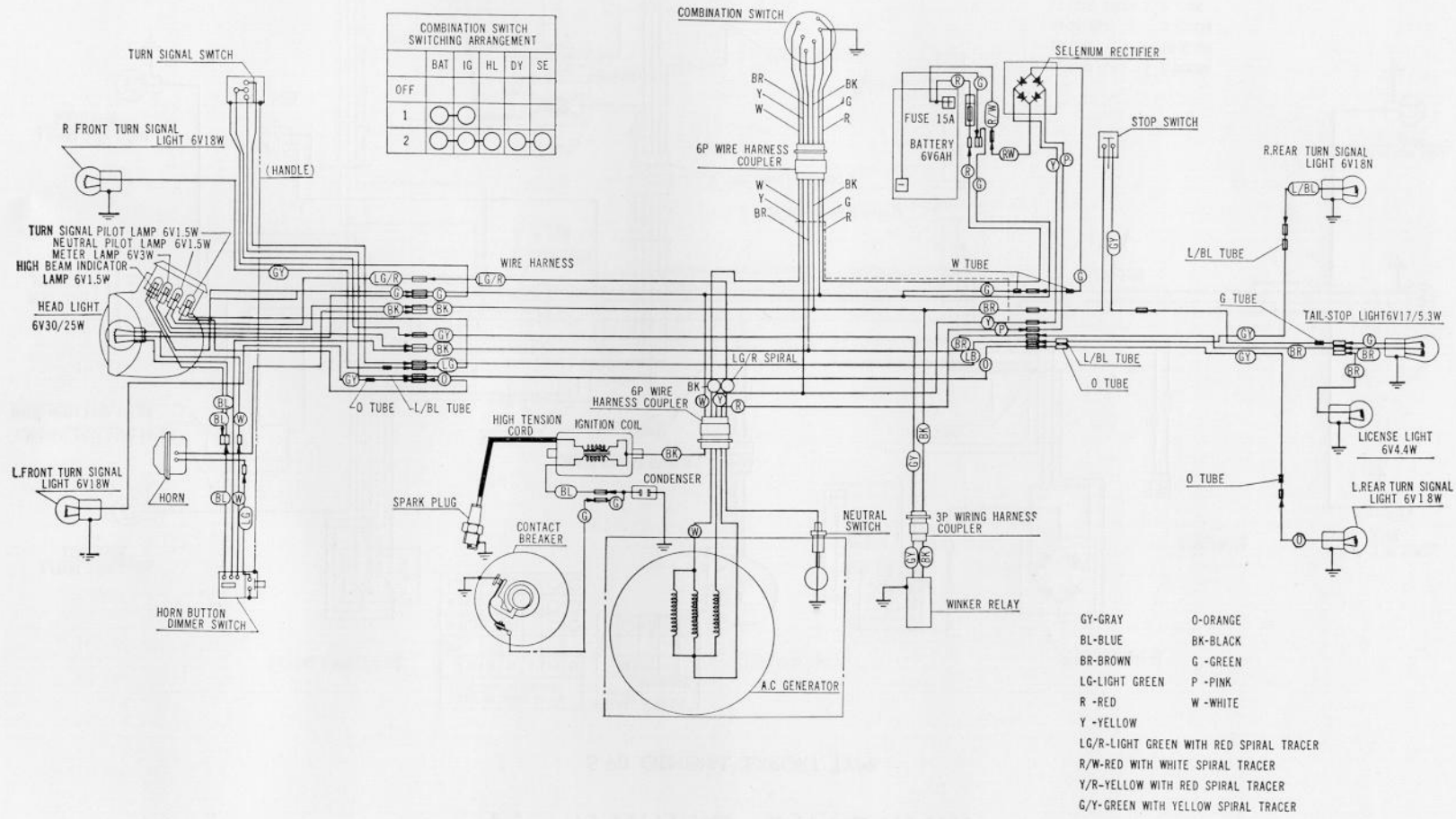



CL 90 GENERAL EXPORT TYPE

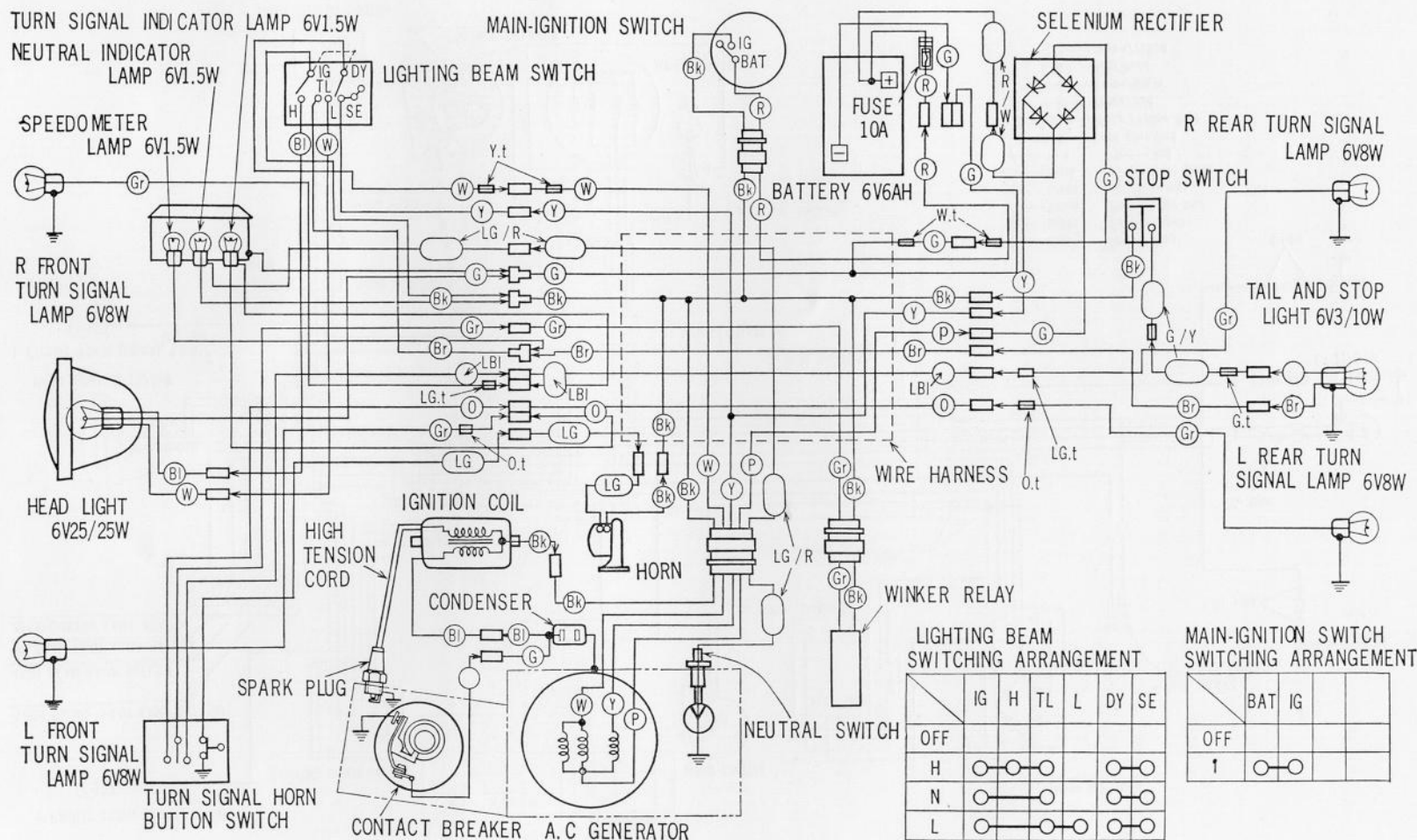

- Bl.....Blue
- W.....White
- Y.t.....Yellow tube
- Gr.....Gray
- Br.....Brown
- LBl.....Light blue
- Y.....Yellow
- G.....Green
- Bk.....Black
- O.....Orange
- LG.....Light green
- LG/R.....Light green and Red
- P.....Pink
- W.t.....White tube
- LG.t.....Light green tube
- O.t.....Orange tube
- G.t.....Green tube
- G/Y.....Green and Yellow

LIGHTING BEAM SWITCHING ARRANGEMENT

	IG	H	TL	L	DY	SE
OFF						
H	○—○	○—○			○—○	
N	○—○				○—○	
L	○—○	○—○			○—○	

MAIN-IGNITION SWITCH SWITCHING ARRANGEMENT

	BAT	IG		
OFF				
1	○—○			

CL 90, CL 90 L U. S. A. EXPORT TYPE

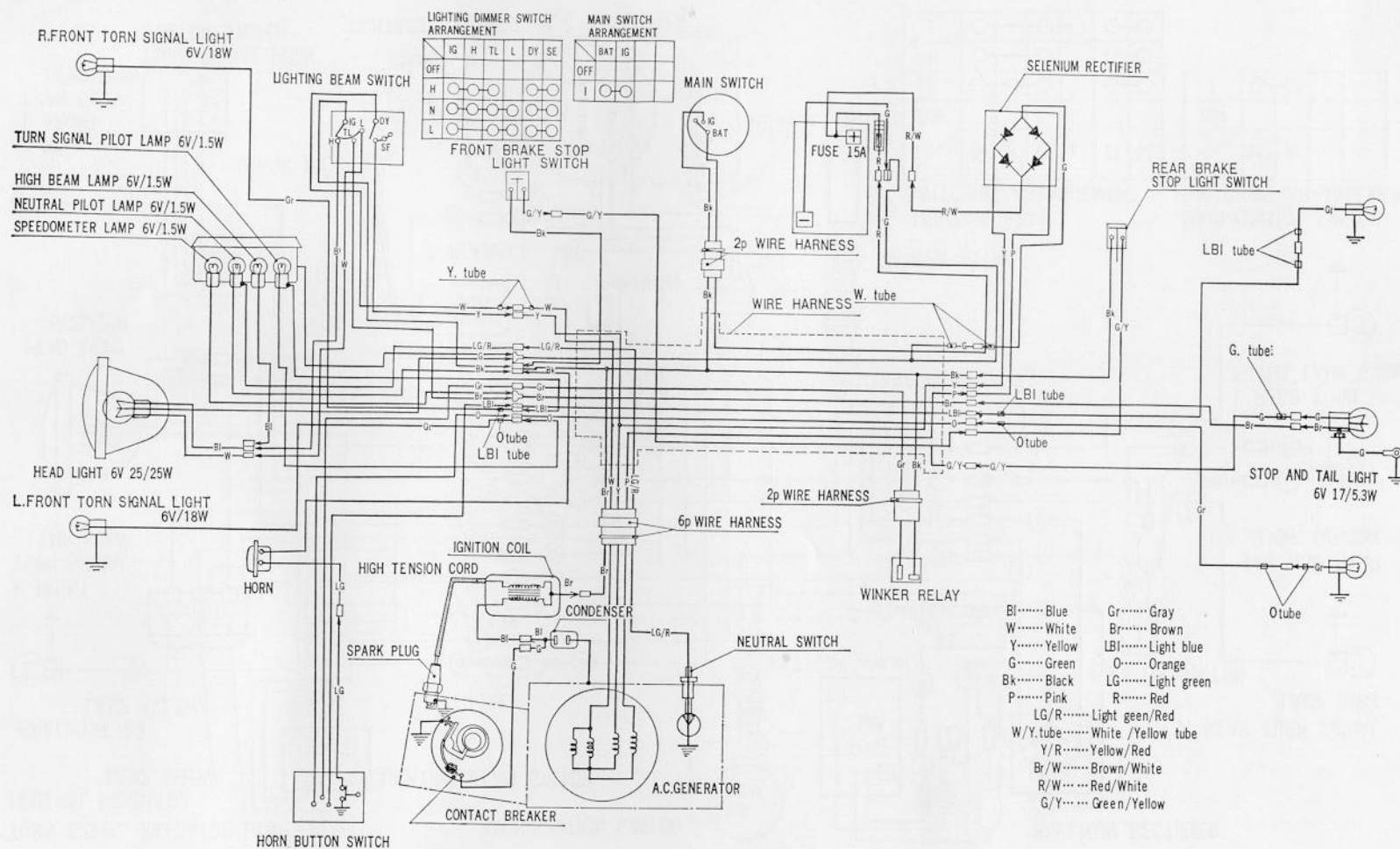

CD 90

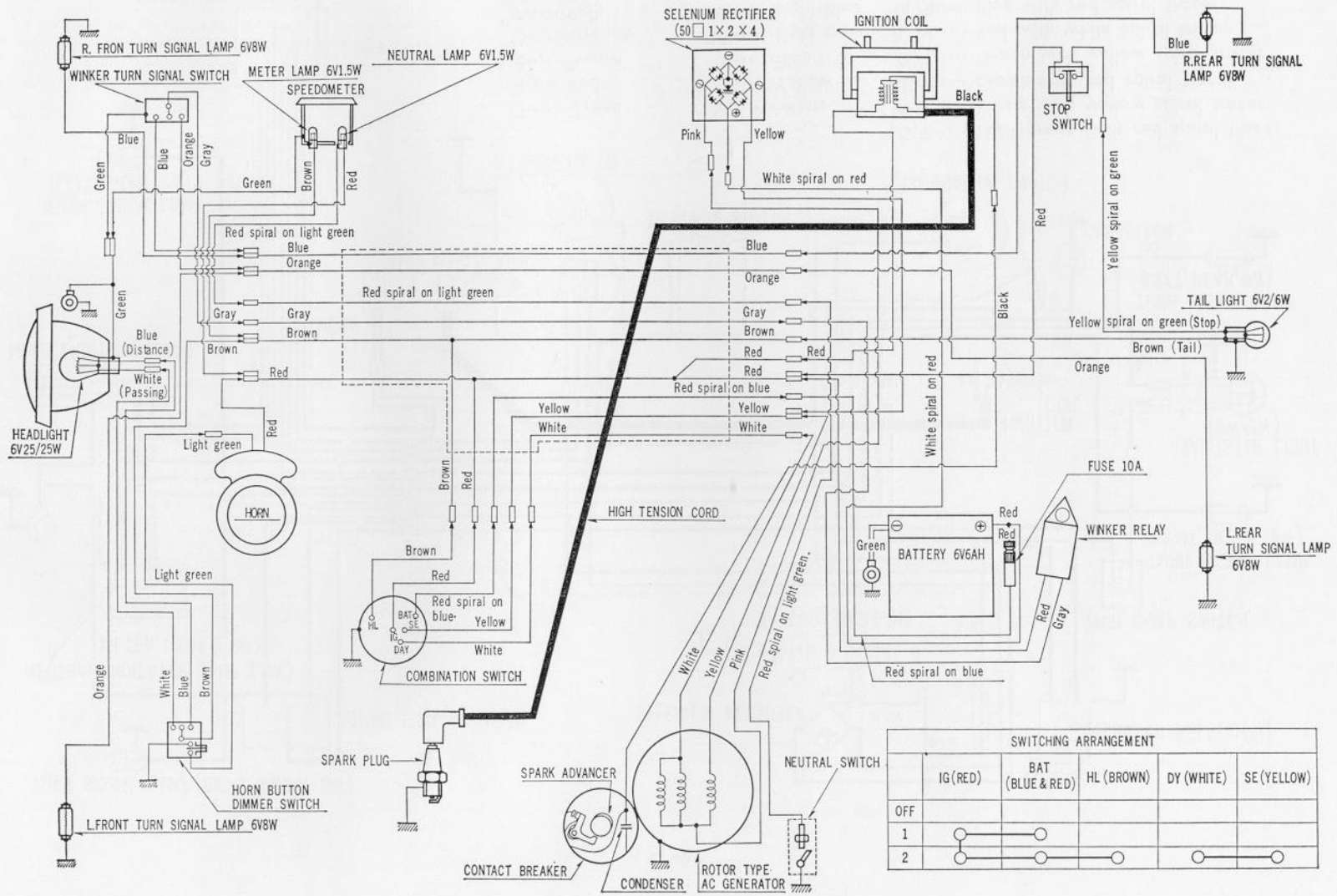

SWITCHING ARRANGEMENT

	IG (RED)	BAT (BLUE & RED)	HL (BROWN)	DY (WHITE)	SE (YELLOW)
OFF					
1	○	○			
2	○	○	○	○	

CD 90

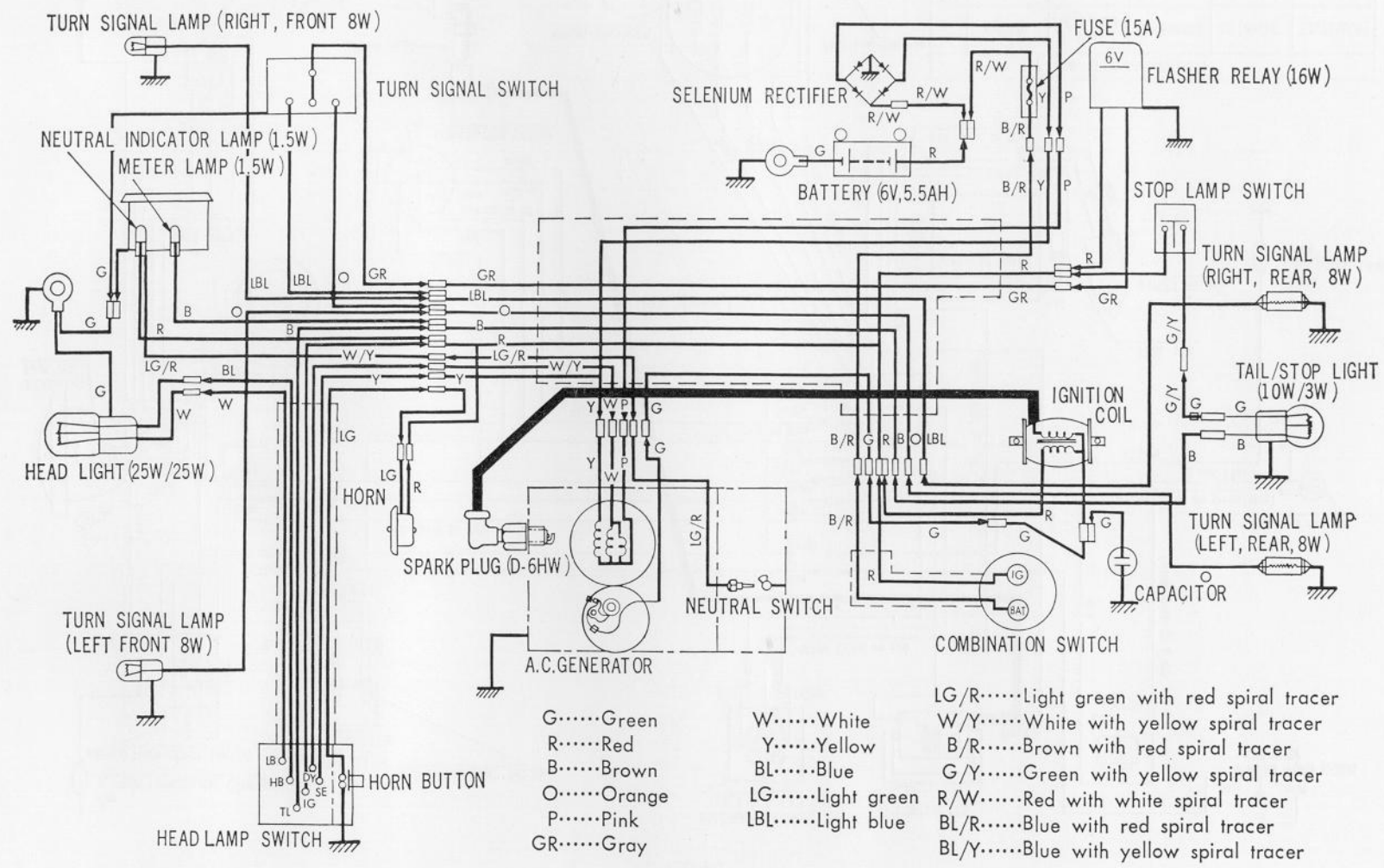



CT 90 (FROM F. No. 000001A)

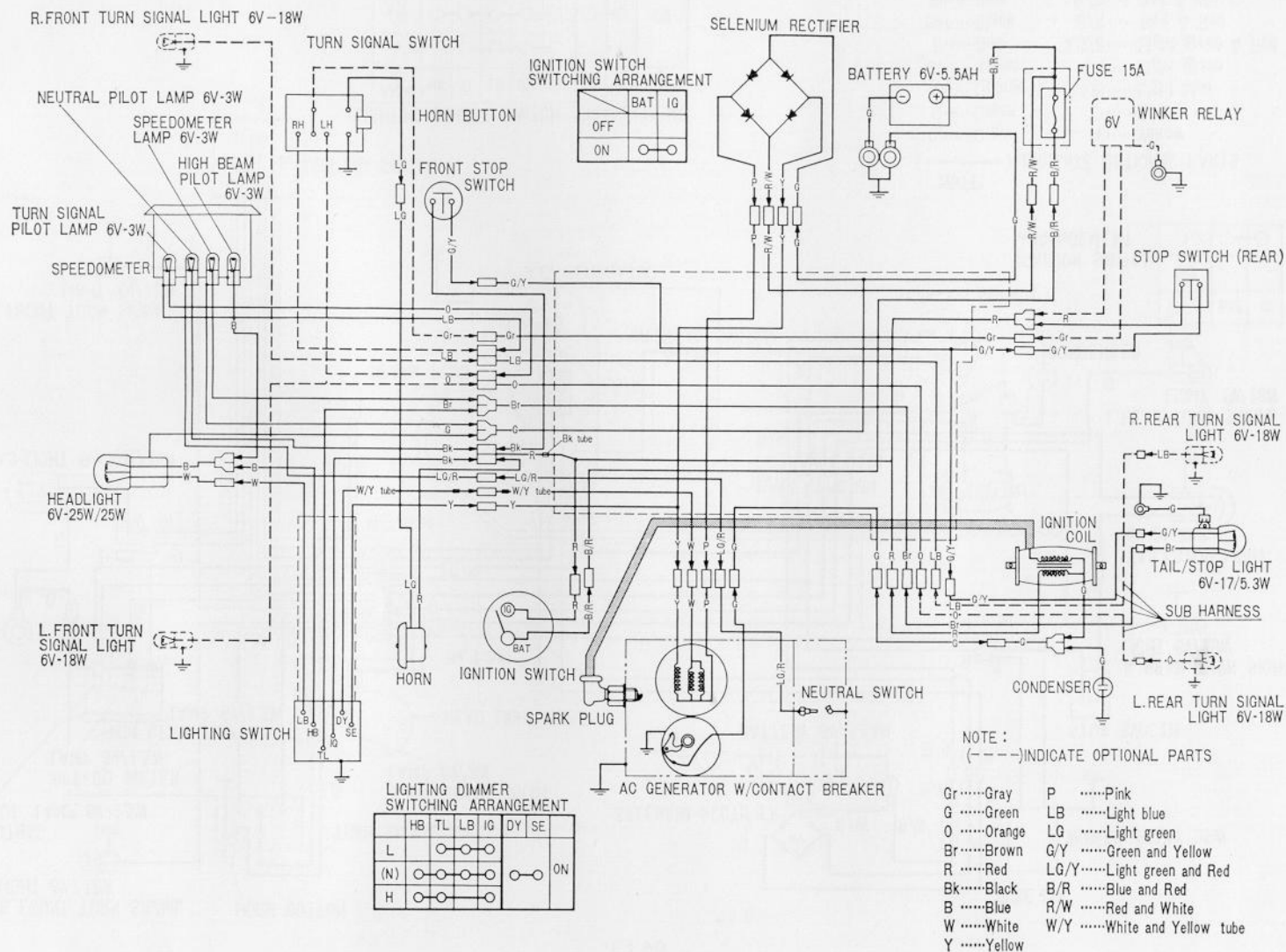

## 8. SUPPLEMENT TO S90ZK1

### 1. CAM CHAIN TENSIONER

The cam chain tensioner was changed from the hydraulic self-adjusting type to the manually adjustable type.

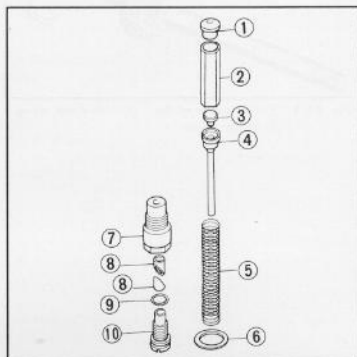

Fig. K1.1 ① Rubber tensioner ⑥ Sealing washer (14mm)  
② Tensioner push rod ⑦ Sealing bolt  
③ Rubber push ⑧ Push rod lock collar  
④ Tensioner push rod B ⑨ O-ring  
⑩ Tensioner adjusting bolt  
⑤ Spring

If the cam chain is excessively noisy with the engine idling, the tension of the cam chain is improper and requires adjustment.

1. To adjust, turn the adjusting bolt in or out as necessary.

Turn the adjusting bolt in a clockwise direction when the chain produces a chattering noise, and turn it in a counterclockwise in case of a whining noise. Set the adjusting bolt to a point where the chain noise is the smallest.

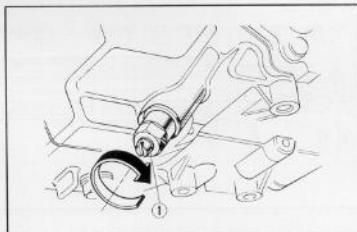

Fig. K1.2 ① Adjusting bolt

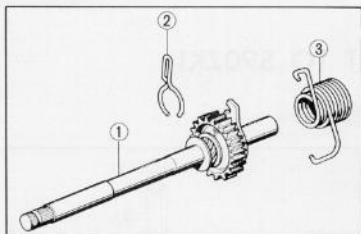

Fig. K1.3 ① Kick starter spindle ② Ratchet spring  
③ Kick starter spring

## 2. KICK STARTER

The kick starter was changed to a new type as shown in Fig. K1-3.

## 3. CARBURETOR

Setting table

Setting number	59A
Main jet	# 68
Slow jet	# 38
Jet needle setting	
Air screw opening	1 + 1/4 ± 1/8 turns
Floot height (gauge)	21 mm (0.827-in.)

## 4. FRONT SHOCK ABSORBER (FRONT FORK)

Oil capacity: 130~140 cc (4.4~4.7 ozs.)

Oil specification ATF (Automatic Transmission Fluid)

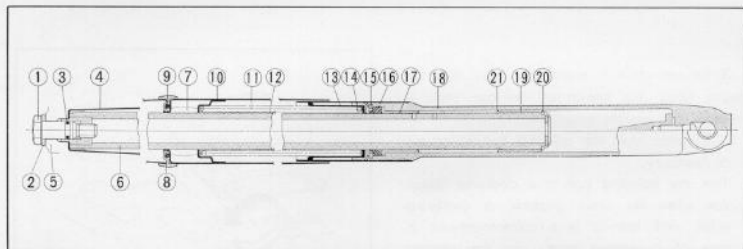

Fig. K1.4

- |                          |                                     |                          |
|--------------------------|-------------------------------------|--------------------------|
| ① Front fork bolt        | ⑨ Front fork rib                    | ⑮ Snapping ring 137 mm   |
| ② Washer (13.2×24 mm)    | ⑩ Fork rib gasket                   | ⑯ Oil seal               |
| ③ O-ring (8.4×2.4 mm)    | ⑪ Fork under cover guide            | ⑰ Front fork pipe guide  |
| ④ Front fork upper cover | ⑫ Front shock absorber spring       | ⑱ Front fork bottom case |
| ⑤ Fork top bridge        | ⑬ Shock absorber spring guide       | ⑲ Front fork piston      |
| ⑥ Front fork pipe        | ⑭ Shock absorber spring under guide | ⑳ Snap ring              |
| ⑦ Fork bottom bridge     | ⑰ Bottom case cover                 | ㉑ Piston stop ring       |



### 5. REAR SHOCK ABSORBER (REAR CUSHION)

Spring free length: 173.5 mm (6.831 in.)

Installed length/Load:

159.1 mm/19.3 kg (6.264 in./42.55 lbs.)

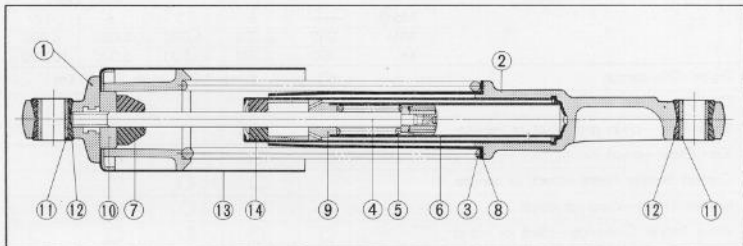

Fig. K1.5

- |                                    |                |                         |
|------------------------------------|----------------|-------------------------|
| ① Rear shock absorber upper metal  | ⑥ Inner pipe   | ⑪ Rubber bushing collar |
| ② Rear shock absorber bottom metal | ⑦ Rubber stop  | ⑫ Rubber bushing        |
| ③ Rear shock absorber spring       | ⑧ Spring guide | ⑬ Upper case            |
| ④ Rear shock absorber rod          | ⑨ Rod guide    | ⑭ Oil seal              |
| ⑤ Rebound stop spring              | ⑩ Lock nut     |                         |

### 6. WHEEL AXLE NUT

The front and wheel axle nuts were changed to a castle nut that is fixed by a cotter pin.

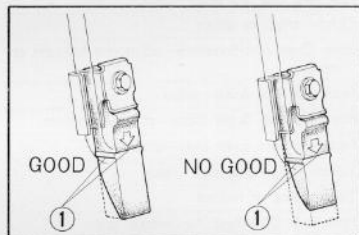
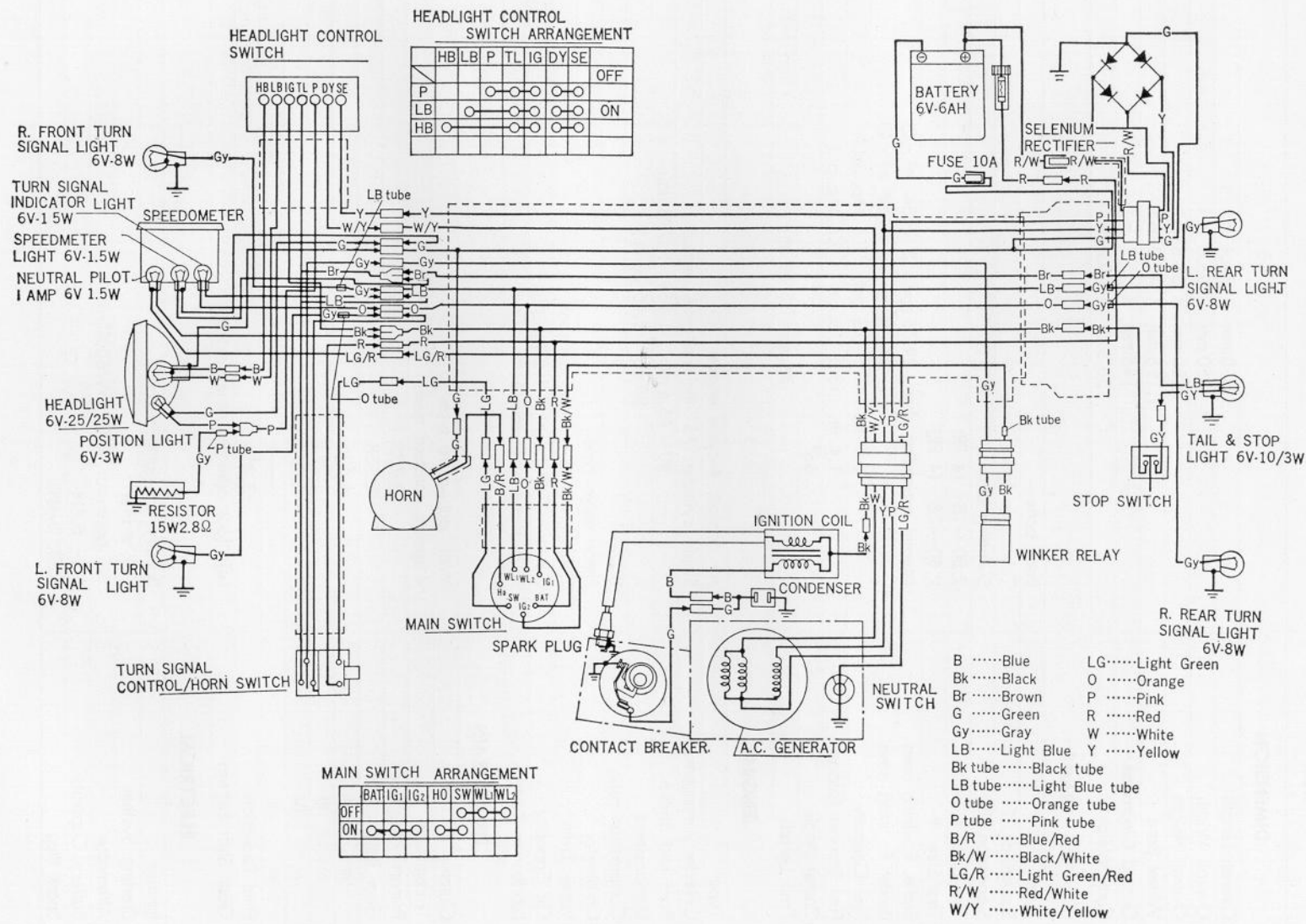

Fig. K1.6 ① Wheel axle nut ② Cotter pin

## 7. MAINTENANCE SCHEDULE

Service Required	Months or Miles, whichever occurs first					
		First	Second	Third	Thereafter Repeat Every	
	Month	—	6	12	6 12	
	Mile	200	3,000	6,000	3,000 6,000	
	Km	300	5,000	10,000	5,000 10,000	
Engine Oil—change	<input type="radio"/>	Every 1,000 Miles (1,600 Km)				
Oil Filter—clean	<input type="radio"/>		<input type="radio"/>	<input type="radio"/>	<input type="radio"/>	
Spark Plugs—clean and adjust or replace			<input type="radio"/>	<input type="radio"/>	<input type="radio"/>	
Cam Chain—adjust	<input type="radio"/>	<input type="radio"/>	<input type="radio"/>	<input type="radio"/>		
Contact Breaker Points—check or service		<input type="radio"/>	<input type="radio"/>	<input type="radio"/>		
Ignition Timing—check or adjust	<input type="radio"/>	<input type="radio"/>	<input type="radio"/>	<input type="radio"/>		
Valve Tappet Clearance—check or adjust	<input type="radio"/>	<input type="radio"/>	<input type="radio"/>	<input type="radio"/>		
Air Cleaner—clean and replace		<input type="radio"/>	<input type="radio"/>		<input type="radio"/>	
Throttle Operation—check		<input type="radio"/>	<input type="radio"/>	<input type="radio"/>		
Carburetor—check or adjust		<input type="radio"/>	<input type="radio"/>	<input type="radio"/>		
Fuel Valve Strainer—clean		<input type="radio"/>	<input type="radio"/>	<input type="radio"/>		
Fuel Tank and Fuel Lines—check		<input type="radio"/>	<input type="radio"/>	<input type="radio"/>		
Clutch—check or adjust	<input type="radio"/>	<input type="radio"/>	<input type="radio"/>	<input type="radio"/>		
Drive Chain and Sprockets—adjust and lubricate or replace	<input type="radio"/>	<input type="radio"/>	<input type="radio"/>	<input type="radio"/>		
Front and Rear Brake—adjust	<input type="radio"/>	<input type="radio"/>	<input type="radio"/>	<input type="radio"/>		
Front and Rear Brake Shoes—check or replace			<input type="radio"/>		<input type="radio"/>	
Front and Rear Brake Links—check		<input type="radio"/>	<input type="radio"/>	<input type="radio"/>		
Wheel Rims and Spokes—check	<input type="radio"/>	<input type="radio"/>	<input type="radio"/>	<input type="radio"/>		
Tires—check or replace		<input type="radio"/>	<input type="radio"/>	<input type="radio"/>		
Front Fork Oil—check for leakage and change		<input type="radio"/>			<input type="radio"/>	
Steering Head Bearings—check or adjust			<input type="radio"/>		<input type="radio"/>	
Steering Handle Lock—check for operation			<input type="radio"/>		<input type="radio"/>	
Side Stand Spring—check		<input type="radio"/>	<input type="radio"/>	<input type="radio"/>		
Battery Electrolyte Level—check and replenish if necessary	<input type="radio"/>	<input type="radio"/>	<input type="radio"/>	<input type="radio"/>		
Lights, Horn, Speedometer—check for operation or adjust		<input type="radio"/>	<input type="radio"/>	<input type="radio"/>		

8. WIRING DIAGRAM



8. SUPPLEMENT TO S 90 ZK 1

## 9. SPECIFICATIONS

Item	
<b>DIMENSION</b>	
Overall Length	1,890 mm ( 74.4 in.)
Overall Width	650 mm ( 25.6 in.)
Overall Height	980 mm ( 38.6 in.)
Wheel Base	1,195 mm ( 47.0 in.)
Ground Clearance	145 mm ( 5.7 in.)
Curb Weight	36.5 kg (190.7 lb.)
<b>FRAME</b>	
Type	Back bone
Suspension, F	Telescopic fork
Suspension, R	Swinging arm
Tire Size, F	2.50—18 (4 PR)
Tire Size, R	2.50—18 (4 PR)
Brake, F, lining area	Internal expanding shoe, 24.75 cm <sup>2</sup> × 2 (3.84 in <sup>2</sup> × 2)
Brake, R, lining area	" , 24.75 cm <sup>2</sup> × 2 (3.84 in <sup>2</sup> × 2)
Fuel Capacity	7.0 lit. (1.8 U.S. gal., 1.5 Imp. gal.)
Fuel Reserve Capacity	1.4 lit. (3.0 U.S. pt., 2.5 Imp. pt.)
Caster Angle	65°
Trail Length	75 mm (2.95 in.)
<b>ENGINE</b>	
Type	Air cooled, 4-cycle engine
Cylinder Arrangement	Single cylinder, 75° inclined from vertical
Bore and Stroke	50 × 45.6 mm (1.969 × 1.795 in.)
Displacement	89 cc (5.45 cu.in.)
Compression ratio	8.7 : 1
Carburetor	Piston valve type
Valve Train	Chain driven over head camshaft
Oil Capacity	0.9 lit. (1.9 U.S. pt., 1.6 Imp. pt.)
Lubrication System	Forced and wet sump
<b>DRIVE TRAIN</b>	
Clutch	Wet, multi-plate type
Transmission	4-speed, constant mesh
Primary Reduction	3.722
Gear Ratio I	2.538
" II	1.526
" III	1.091
" IV	0.880
" V	—
Final Reduction	3.214
Gear Shift Pattern	Left foot operate, return system
<b>ELECTRICAL</b>	
Ignition	Battery and ignition coil
Starting System	Kick starter
Alternator	AC generator, 0.05 kW/6000 rpm
Battery Capacity	6 V—6 AH
Spark Plug	NGK D-6HS

## 9. SUPPLEMENT TO CT90K2~K6

### CT90K2

#### COMPARISON OF CT90K2-K3 TO CT90

##### 1. KICK STARTER

The kick starter was changed to a new type as shown in Fig. K2-1.

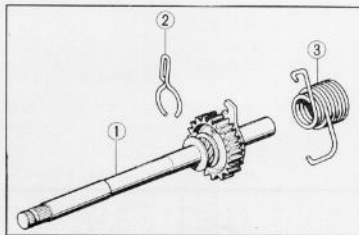

Fig. K2.1 ① Kick starter spindle ③ Kick starter spring  
② Ratchet spring

##### 2. AIR CLEANER

The air cleaner was new for the revised model. Concurrent with this change, the maintenance procedures of the cleaner element was changed.

##### Maintenance

1. Remove the wing nut and loosen the air cleaner connecting tube clamp, then remove the air cleaner case lid.
2. Unscrew the fixing plate bolt and remove the fixing plate.
3. Pull out the air cleaner element from the air cleaner case.
4. Wash the air cleaner element in clean Stoddard solvent and allow to dry thoroughly.

##### WARNING:

Gasoline or low flash point solvents are highly flammable and must not be used to clean air cleaner element.

5. Soak the air cleaner element in clean gear oil (SAE No. 80 or 90) until saturated, then squeeze out excess oil.
6. Reinstall the air cleaner element.
7. Reinstall the air cleaner case lid.

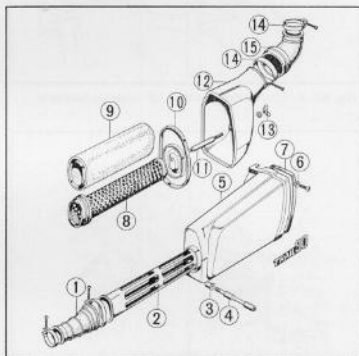



Fig. K2.2

- |                         |                        |
|-------------------------|------------------------|
| ① Connecting tube A     | ⑩ Air cleaner element  |
| ② Element inner pipe    | ⑪ Fixing plate         |
| ③ Cleaner case collar   | ⑫ Fixing plate bolt    |
| ④ Cleaner case bolt     | ⑬ Air cleaner case lid |
| ⑤ Air cleaner case      | ⑭ Wing nut             |
| ⑥ Cleaner case collar B | ⑮ Tube clamp           |
| ⑦ Cleaner case gasket   | ⑯ Connecting tube B    |
| ⑧ Element holder        |                        |

### 3. CARBURETOR

#### Setting table

Setting number	K29B
Main jet	#65
Slow jet	#35
Jet needle setting	 3rd. groove
Air screw opening	1 ± 1/8 turn
Float height (gauge)	20 mm (0.787-in.)

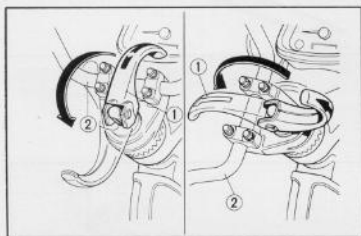

Fig. K2.3 ① Handlebar clamp ② Steering handlebar

### 4. STEERING HANDLEBAR CLAMP

The steering handle was changed to a new type with a handlebar clamp. The handlebar can be set in longitudinal position to economize loading space when transporting the motorcycle.

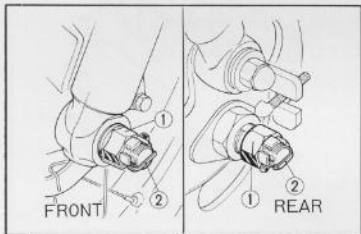

Fig. K.24 ① Axle nut ② Cotter pin

### CT90K3

#### 1. WHEEL AXLE

The front and rear wheel axle nuts were changed to a new axle nuts.

## CT90K4

## COMPARISON OF CT90K4 TO CT90K3

## 1. CAM CHAIN TENSIONER

The cam chain tensioner was changed from the hydraulic self-adjusting type to the manually adjustable type.

## Adjustment

Make tension adjustment while the engine is idling.

1. Loosen the lock nut and loosen the tensioner adjusting bolt approximately one half turn.

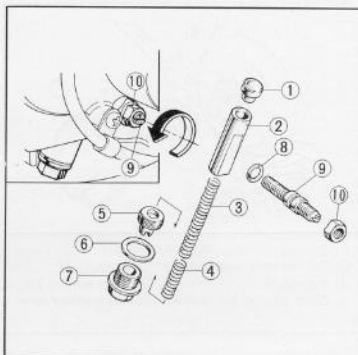

Fig. K4.1

- |                           |                            |
|---------------------------|----------------------------|
| ① Tensioner push rod head | ⑥ Sealing washer           |
| ② Tensioner push rod      | ⑦ 14 mm sealing bolt       |
| ③ Tensioner spring A      | ⑧ O-ring                   |
| ④ Tensioner spring B      | ⑨ Tensioner adjusting bolt |
| ⑤ Tensioner bolt          | ⑩ Lock nut                 |

2. If the chain is still noisy even after the adjustment above, loosen the 14 mm sealing bolt located at the left bottom side of the crankcase, and screw in the tensioner bolt gradually until it is no longer noisy.

After completing the adjustment, tighten the tensioner adjusting bolt lock nut and 14 mm sealing bolt securely.

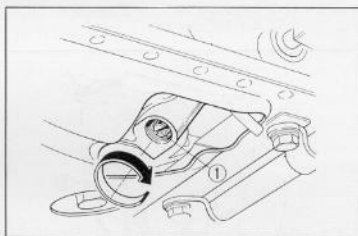

Fig. K4.2 ① Tensioner bolt

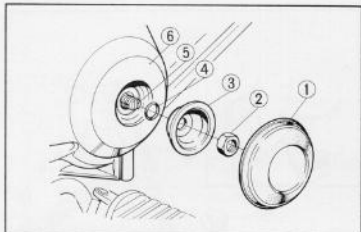

Fig. K4.3

- ① Right crankcase cover protector    ④ O-ring  
 ② 8 mm nut    ⑤ Clutch adjusting bolt  
 ③ Clutch adjusting bolt washer    ⑥ Right crankcase cover

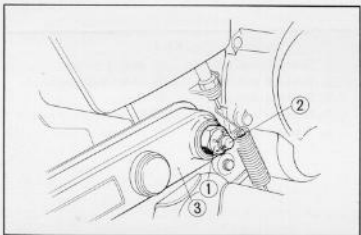

Fig. K4.4 ① Self-locking nut    ③ Rear fork  
 ② Rear fork pivot bolt

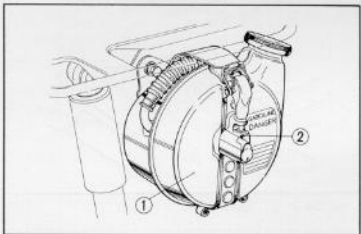



Fig. K4.5 ① Fuel sub tank    ② Helmet holder

## 2. RIGHT CRANKCASE COVER

A new protector was installed to the right crankcase cover.

## 3. CARBURETOR

### Setting table

Setting number	556 A
Main jet	№62
Slow jet	№35
Jet needle setting	 3rd. groove
Air screw opening	1 ± 1/8 turn
Floot height (gauge)	20 mm (0.787-in.)

## 4. REAR FORK

The rear fork pivot bolt securing nut was changed to a new self-locking nut.

## 5. FUEL SUB TANK

A new fuel sub tank with a helmet holder was installed on the left lower side of the carrier.  
 Capacity: 0,8 lit. (0,2 U.S. gal.)



## CT90K5

## COMPARISON OF CT90K5 TO CT90K4

## 1. ENGINE STOP SWITCH

A new engine stop switch was added to the headlight switch housing at the right side of the handlebar.

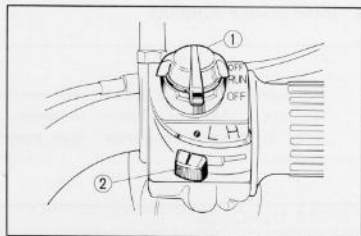

Fig. K5.1 ① Engine stop switch ② Headlight switch

## 2. BRAKE WEAR INDICATOR

On the CT90K5, new wear indicators were provided in the front and rear brakes. When the brake applied, an arrow, adjacent to the brake arm, moves toward a reference mark on the brake panel. The distance between the arrow and the reference mark, on full application of the brake, indicates brake lining thickness.

## 3. REAR BRAKE

The rear lever brake at the left side of the handlebar, hitherto offered, was discontinued.

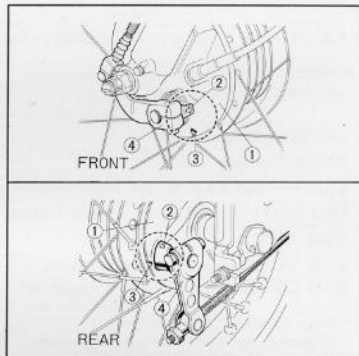

Fig. K5.1 ① Brake panel ② Arrow  
③ Reference mark ④ Brake

## 4. MAINTENANCE SCHEDULE

	INITIAL SERVICE PERIOD	REGULAR SERVICE PERIOD				
		500 miles	1 month 500 miles	3 months 1,500 miles	6 months 3,000 miles	12 months 6,000 miles
This maintenance schedule is based upon average riding conditions. Machines subjected to severe use, or ridden in unusually dusty areas, require more frequent servicing.						
ENGINE OIL—Change.	●		○			
CENTRIFUGAL OIL SCREEN—Clean.						○
OIL FILTER SCREEN—Clean.						○
SPARK PLUG—Clean and adjust gap or replace if necessary.					○	
CONTACT POINTS AND IGNITION TIMING—Clean, check, and adjust or replace if necessary.	●				○	
*VALVE TAPPET CLEARANCE—Check, and adjust if necessary.	●				○	
*CAM CHAIN TENSION—Adjust.	●				○	
POLYURETHANE FOAM AIR FILTER ELEMENT—Clean and oil.			(Service more frequently if operated in dusty areas) ○			
*CARBURETOR—Check, and adjust if necessary.	●				○	
THROTTLE OPERATION—Inspect cable. Check, and adjust free play.	●				○	
FUEL FILTER SCREEN—Clean.					○	
FUEL LINES—Check.					○	
*CLUTCH—Check operation, and adjust if necessary.	●				○	
DRIVE CHAIN—Check lubricate, adjust if necessary.	**●	○				
SPARK ARRESTOR—Purge			○			
BRAKE SHOES—Inspect, and replace if worn.					○	
BRAKE CONTROL LINKAGE—Check linkage and adjust free play if necessary.	●				○	
*WHEEL RIMS AND SPOKES—Check. Tighten spokes and true wheels, if necessary.	●				○	
TIRES—Inspect and check air pressure.	●	○				
FRONT FORK OIL—Drain and refill.	***●					○
FRONT AND REAR SUSPENSION—Check operation.					○	
REAR FORK BUSHING—Grease, check for excessive looseness.					○	
*STEERING HEAD BEARINGS—Adjust.						○
BATTERY—Check electrolyte level, and add water if necessary.	●		○			
LIGHTING EQUIPMENT—Check and adjust if necessary.	●	○				
ALL NUTS, BOLTS, AND OTHER FASTNERS—Check security and tighten if necessary.	●	○				

Items marked \* should be serviced by an authorized Honda dealer, unless the owner has proper tools and is mechanically proficient. Other maintenance items are simple to perform and may be serviced by the owner.

\*\* INITIAL SERVICE PERIOD 200 MILES.

\*\*\* INITIAL SERVICE PERIOD 1,500 MILES.

5. WIRING DIAGRAM

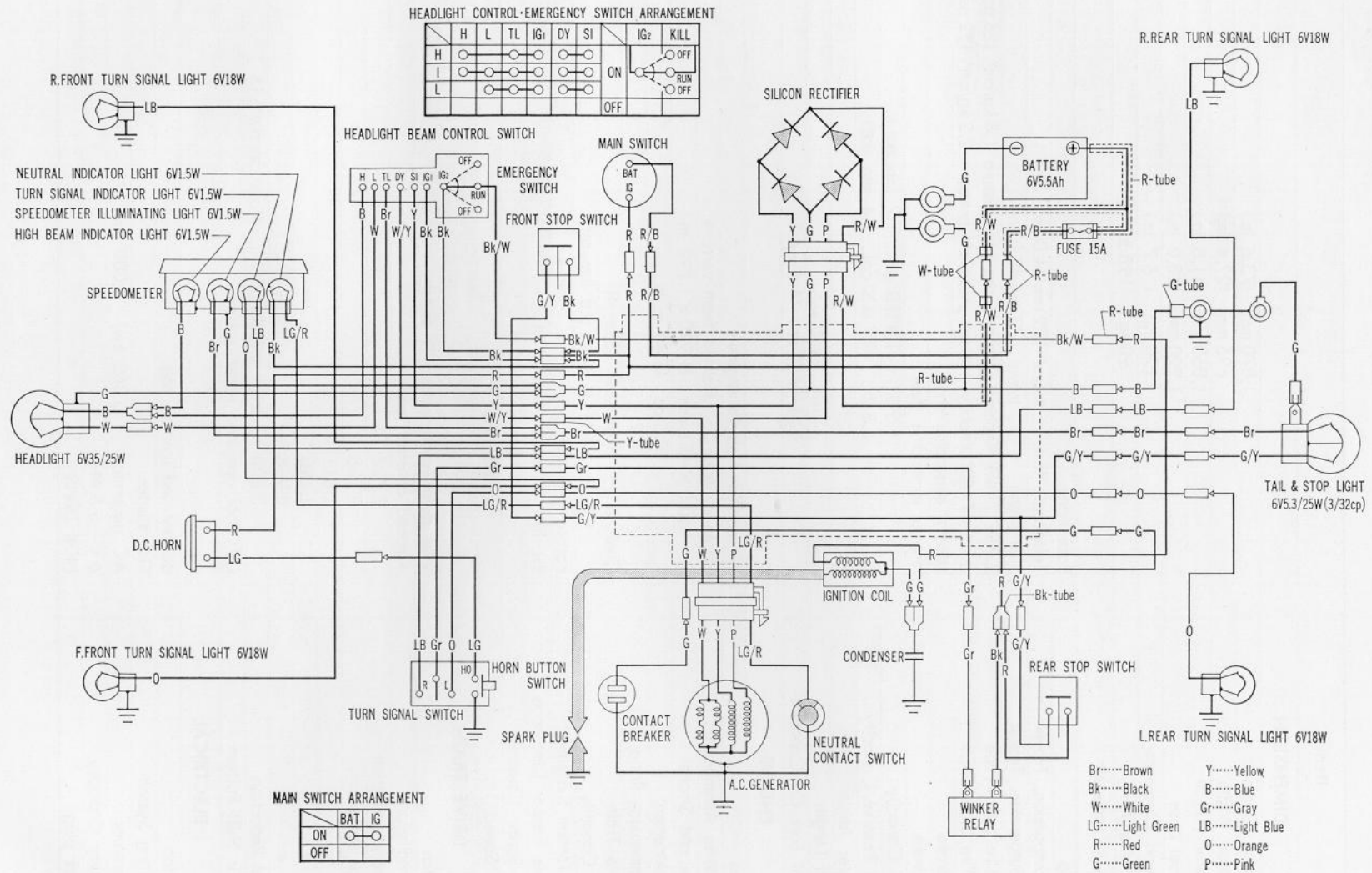

HEADLIGHT CONTROL-EMERGENCY SWITCH ARRANGEMENT

	H	L	TL	IG <sub>1</sub>	DY	SI	IG <sub>2</sub>	KILL
H	○	○	○	○	○	○	○	○
L	○	○	○	○	○	○	○	○
TL	○	○	○	○	○	○	○	○
IG <sub>1</sub>	○	○	○	○	○	○	○	○
DY	○	○	○	○	○	○	○	○
SI	○	○	○	○	○	○	○	○
IG <sub>2</sub>	○	○	○	○	○	○	○	○
KILL	○	○	○	○	○	○	○	○
ON	○	○	○	○	○	○	○	○
OFF	○	○	○	○	○	○	○	○

MAIN SWITCH ARRANGEMENT

	BAT	IG
ON	○	○
OFF	○	○

9. SUPPLEMENT TO CT 90 K2-K6

## 6. SPECIFICATIONS

Item	
<b>DIMENSION</b>	
Overall Length	1,870 mm (73.6 in.)
Overall Width	695 mm (27.4 in.)
Overall Height	1,050 mm (41.3 in.)
Wheel Base	1,220 mm (48.0 in.)
Ground Clearance	170 mm ( 6.7 in.)
Dry Weight	90 kg (198 lb.)
<b>FRAME</b>	
Type	Back bone
F. Suspension, Travel	Telescopic fork , travel 102 mm (4.0 in.)
R. Suspension, Travel	Swing arm , travel 77 mm (3.0 in.)
F. Tire Size, Type	2.75-17-4PR Knobby pattern , tire air pressure 1.8 kg/cm <sup>2</sup> (26 psi)
R. Tire Size, Type	2.75-17-4PR Knobby pattern , tire air pressure 2.2 kg/cm <sup>2</sup> (32 psi)
F. Brake	Internal expanding shoe
R. Brake	Internal expanding shoe
Fuel Capacity	5.5 lit. (1.4 U.S. gal., 1.2 Imp. gal.)
Fuel Reserve Capacity	0.8 lit. (1.7 U.S. gal., 1.4 Imp. gal.)
Caster Angle	63°
Trail Length	75 mm (3.0 in.)
Front Fork Oil Capacity	134-140 cc (4.4-4.7)
<b>ENGINE</b>	
Type	Air cooled 4-stroke engine
Cylinder Arrangement	Single cylinder 75° inclined from vertical
Bore and Stroke	50.0 × 45.6 mm (1.970 × 1.797 in.)
Displacement	89.5 cc (5.46 cu in.)
Compression Ratio	8.2
Valve Train	Chain driven over head camshaft
Oil Capacity	0.9 lit. 10.95 U.S. qt, 0.8 Imp. qt)
Lubrication System	Forced and wet sump
Valve Tappet Clearance	IN, EX : 0.05 mm (0.002 in.)
Ais Screw Opening	1 turn
Idle Speed	1,300 rpm
<b>DRIVE TRAIN</b>	
Clutch	Wet multi-plate automatic clutch
Transmission	4-speed constant mesh
Primary Reduction	3.722
Gear Ratio I	2.538
"    II	1.611
"    III	1.190
"    IV	0.958
Final Reduction	3.000 , drive sprocket 15 T, driven sproket 45 T
Gear Shift Pattern	Left foot operated return system
<b>ELECTRICAL</b>	
Ignition	Battery and ignition coil
Starting System	Kick starter
Alternator	AC generator 0.062 kw/ 6,000 rpm
Battery Capacity	6 V-5.5 AH
Spark plug	NGK D8HS

CT90K6

## COMPARISON OF CT90K6

## 1. FUEL COCK

The indication marks and their positions on the fuel cock was changed to a new type.

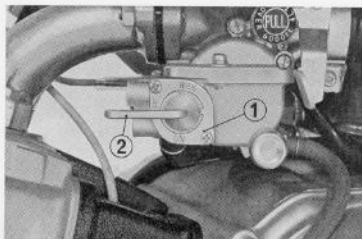

Fig. K6.1 ① Fuel cock ② Lever

## 2. HEADLIGHT AND ENGINE STOP SWITCH

The dimmer switch, previously offered on the switch housing at the right side of the handlebar, was relocated to the left switch housing. This also necessitated changes in the design of the switch housing.

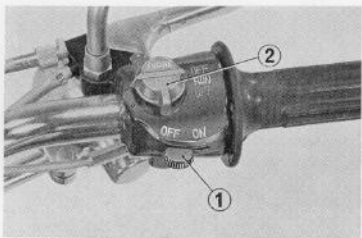

Fig. K6.2 ① Headlight switch ② Engine stop switch

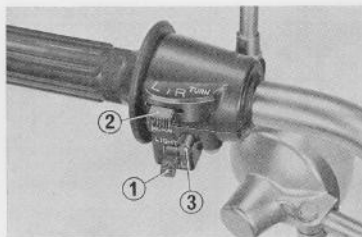

Fig. K6.3 ① Dimmer switch  
② Turn signal switch  
③ Horn switch

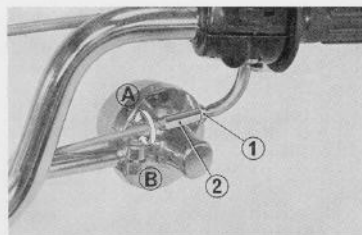

Fig. K6.4 ① Lock nut ② Upper adjuster

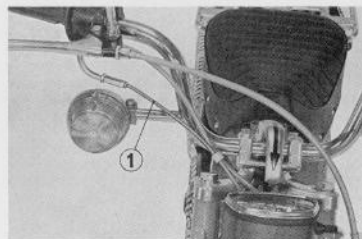

Fig. K6.5 ① Throttle cable

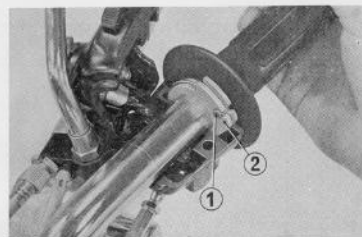

Fig. K6.6 ① Throttle cable end ② Grip pipe

### 3. TURN SIGNAL, HORN AND DIMMER SWITCH

A new dimmer switch was added to the turn signal and horn switch housing at the left side of the handlebar.

### 4. THROTTLE GRIP

The throttle grip was changed to a new, wind-in type.

#### Inspection and adjustment

1. Check the free play of the throttle grip. It should be 10—15 degrees of the grip rotation.
2. To adjust, loosen the lock nut and turn the upper adjuster either in or out as necessary. Rotation of the adjuster in a direction "A" decreases the play, and rotating in a direction "B" increases the play. Tighten the lock nut after adjustment.
3. Check the throttle cable for twisting or interference with adjacent parts; also for proper routing, while turning the handlebar to each extreme.

#### Disassembly

1. Loosen off the screws securing the switch housing; separate the housing.
2. Disconnect the throttle cable end from the throttle grip pipe.
3. Withdraw the throttle grip from the handlebar.
4. Assemble the throttle grip in the reverse order of disassembly.

## 5. SIDE STAND

The side stand was changed to a new type with a shock absorbing rubber block.

This stand must be inspected periodically to determine that it is in good condition.

### Inspection

1. Check the entire side stand assembly (side stand bar, bracket and rubber block) for incorrect installation, deformation or otherwise excessive damage.
2. Check the spring for freedom for damage or other defects.
3. Check the side stand for proper return operation:
  - a. With the stand applied, tilt the machine so that it clears the ground.
  - b. Attach a spring scale to the lower end of the stand and measure the force with which the stand is returned to its original position.
  - c. The stand condition is correct if the measurement falls within 2-3 kg (4.4-6.6 lbs.). If the stand requires force exceeding the above, limit, this might be due to neglected lubrication, overtightened side stand pivot bolt, worn stand bar or bracket, or otherwise excessive tension. Repair as necessary.
4. Check the rubber block for deterioration or wear. When the rubber pad wear is excessive so that it is worn down to the wear line, replace it with a new one.

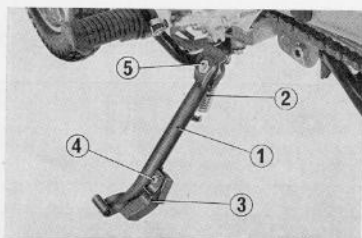

Fig. K6.7 ① Side stand bar ② Spring  
③ Rubber block ④ 6 mm bolt  
⑤ Side stand pivot bolt

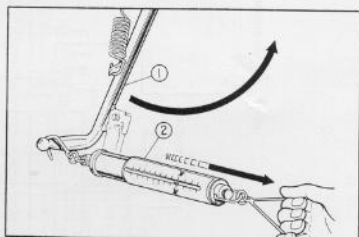

Fig. K6.8 ① Side stand bar ② Spring scale

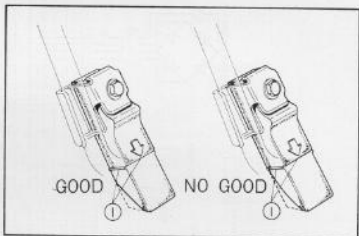

Fig. K6.9 ① Wear line

### Rubber block replacement

1. Remove the 6 mm bolt; separate the rubber block from the bracket at the side stand.
2. After making sure the collar is installed, put a new rubber block in place in the bracket with the arrow mark out.

#### NOTE:

Use rubber pad having the mark "BELOW 259 lbs ONLY"

3. Secure the rubber block.

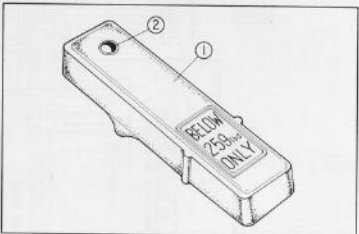

Fig. K6.10 ① Rubber block ② Collar





## 10. SUPPLEMENT TO CT90 K8 ('77)

Engine No. CT90E—180001 and subsequent

Frame No. CT90—180001 and subsequent

## 1. MAINTENANCE SCHEDULE

	INITIAL SERVICE PERIOD		REGULAR SERVICE PERIOD				
	Perform at every indicated month or mileage interval, whichever occurs first.						
	Month	—	1	3	6	12	
	Mile	500	500	1,500	3,000	6,000	
	Km	1,000	1,000	2,500	5,000	10,000	
ENGINE OIL		R		R			
*CENTRIFUGAL OIL FILTER						C	
*OIL FILTER SCREEN						C	
SPARK PLUG					I		
*CONTACT BREAKER POINTS		I			I		
*IGNITION TIMING		I			I		
*VALVE TAPPET CLEARANCE		I			I		
*CAM CHAIN TENSION		I			I		
POLYURETHANE FOAM AIR FILTER ELEMENT		(Service more frequently if operated in dusty areas.)		C			
*CARBURETOR		I			I		
THROTTLE OPERATION		I			I		
FUEL FILTER SCREEN					C		
FUEL LINES					I		
*CLUTCH		I			I		
DRIVE CHAIN		**I & L	I & L				
SPARK ARRESTOR				C			
*BRAKE SHOES					I		
BRAKE CONTROL LINKAGE		I			I		
WHEEL RIMS		I			I		
TIRES		I					
FRONT FORK OIL		***R	I				
FRONT AND REAR SUSPENSION		I			I		
REAR FORK BUSHING					I & L		
*STEERING HEAD BEARINGS						I	
SIDE STAND					I		
BATTERY		I		I			
LIGHTING EQUIPMENT		I	I				
NUTS, BOLTS (TIGHTEN)		I	I				

I—Inspect, clean, adjust or replace if necessary R—Replace C—Clean L—Lubricate

Items marked \* should be serviced by an authorized HONDA dealer, unless the owner has proper tools and is mechanically proficient. Other maintenance items may be serviced by the owner.

\*\* Initial service period 200 miles.

\*\*\* Initial service period 1,500 miles.

2. WIRING DIAGRAM (CT 90 '77)

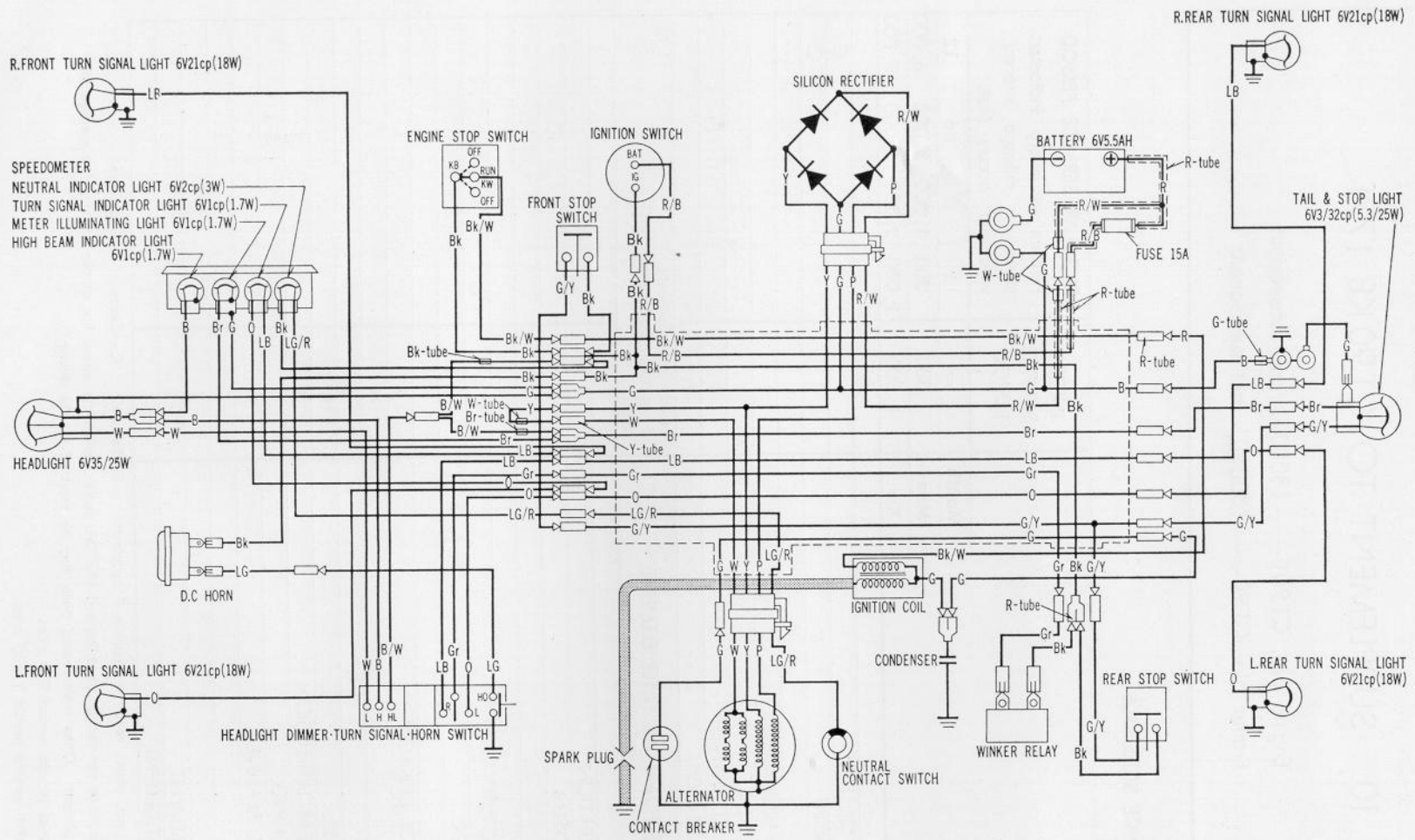

0030Z-102-7800

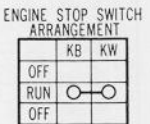
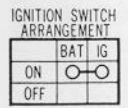
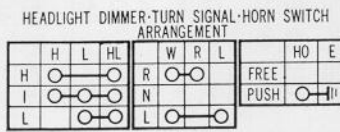

- G.....Green
- R.....Red
- W.....White
- Br.....Brown
- Bk.....Black
- LG.....Light Green
- Y.....Yellow
- B.....Blue
- P.....Pink
- O.....Orange
- Gr.....Grey
- LB.....Light Blue

## 3. SPECIFICATIONS

Item		
<b>DIMENSION</b>		
Overall Length		1,870 mm (73.6 in.)
Overall Width		740 mm (29.1 in.)
Overall Height		1,060 mm (41.7 in.)
Wheel Base		1,220 mm (48.0 in.)
Seat Height		775 mm (30.5 in.)
Ground Clearance		165 mm (6.5 in.)
Dry Weight		90 kg (198.7 lb.)
<b>FRAME</b>		
Type		Double cradle
F. Suspension, Travel		Telescopic fork, travel 102 mm (4.0 in.)
R. Suspension, Travel		Swing arm, travel 77 mm (3.0 in.)
F. Tire Size, Type		2.75-17-4PR Knobby, tire air pressure 1.75 kg/cm <sup>2</sup> , (25 psi.)
R. Tire Size, Type		2.75-17-4PR Knobby, tire air pressure 2.25 kg/cm <sup>2</sup> , (32 psi.)
F. Brake		Internal expanding shoe
R. Brake		Internal expanding shoe
Fuel Capacity		5.5 lit. (1.5 U.S. gal., 1.2 Imp. gal.)
Fuel Reserve Capacity		0.8 lit. (0.21 U.S. gal., 0.18 Imp. gal.)
Caster Angle		63°
Trail Length		75 mm (3.0 in.)
<b>ENGINE</b>		
Type		Air cooled 4-stroke O.H.C. engine
Cylinder Arrangement		Single cylinder 75° inclined from vertical
Bore and Stroke		50 × 45.6 mm (1.970 × 1.797 in.)
Displacement		89.5 cc (5.46 cu. in.)
Compression Ratio		8.2 : 1
Valve Train		Chain driven over head camshaft
Oil Capacity		0.9 lit. (0.95 U.S. qt., 0.8 Imp. qt.)
Lubrication System		Forced and wet sump
Valve Tappet Clearance		IN, EX : 0.05 mm (0.002 in.)
Intake Valve	Opens	5° BTDC
	Closes	20° ABDC
Exhaust Valve	Opens	25° BBDC
	Closes	5° ATDC
Idle Speed		1,300 rpm
<b>DRIVE TRAIN</b>		
Clutch		Wet multi-plate
Transmission		4-speed constant mesh
Primary Reduction		3.722
Gear Ratio I		2.538
Gear Ratio II		1.611
Gear Ratio III		1.190
Gear Ratio IV		0.958
Final Reduction		3,000, drive sprocket 15T, driven sprocket 45T
Gear Shift Pattern		Left foot operated
<b>ELECTRICAL</b>		
Ignition		Battery and ignition coil
Ignition Advance	"F" mark	10° BTDC
	Max. advance	36°-42° BTDC
	RPM from "F" to max. advance	1,950-4,800 rpm
Dwell angle		90° ± 2.5°
Starting System		Kick starter
Alternator		A.C. Generator 0.062 kW/6,000 rpm
Battery Capacity		6 V-5.5 AH
Spark Plug		NGK DR8HS (U.S.A. model) NGK DR8HS (Canadian model)
Condenser Capacity		0.22-0.26 μF